

T H E P O W E R

Knobs & Handles 2025

O F

Viefe[®]

B A L A N C E

**Knobs &
handles**

**2025
collection**

viefe.com

Viefe®

THE POWER OF BALANCE

EN |

The new collection of knobs and handles for 2025 that awaits you in these pages takes its inspiration from the Japanese concept of "Ma" (間), an idea that explores the creative possibilities of negative space or the pause between objects. Like the silence between musical notes or the emptiness in a work of art, "Ma" is the nothingness that explains the whole. The pause in which the imagination can play. A breath of freedom. Far from being mere absence, it is a crucial element that gives meaning to the pure forms of new designs, endowing them with balance and emphasising their power to give meaning to their surroundings. A minimalism that lets each space tell its own story.

ES |

La nueva colección de pomos y tiradores 2025 que descubrirás en estas páginas se inspira en el concepto japonés "Ma" (間), una idea que explora las capacidades creativas del espacio en blanco o la pausa entre objetos. Como el silencio entre las notas musicales o el vacío en una obra de arte, "Ma" es la nada que explica el todo. El intervalo para la imaginación. Un paréntesis de libertad. Lejos de ser solo ausencia, es un elemento crucial que da sentido a las formas puras de los nuevos diseños, les aporta equilibrio y enfatiza su poder de dar significado a los entornos. Su minimalismo deja que cada espacio cuente su propia historia.

CA |

La nova col·lecció de pomos i agafadors 2025 que descobriràs en aquestes pàgines s'inspira en el concepte japonès "Ma" (間), una idea que explora les capacitats creatives de l'espai en blanc o la pausa entre objectes. Com el silenci entre les notes musicals o el buit en una obra d'art, "Ma" és el no-res que explica el tot. L'interval per a la imaginació. Un parèntesi de llibertat. Lluny de ser només absència, és un element crucial que dona sentit a les formes pures dels nous dissenys, els aporta equilibri i emfatitza el poder de donar significat als entorns. El seu minimalisme deixa que cada espai expliqui la seva pròpia història.

Viefe[®]



DESIGN WITHOUT BORDERS

EN |

The world is our playground. Our brand is international in spirit, open to all lifestyles and ways of understanding décor. You can find our products in architecture and interior design projects all over the globe; professionals and private individuals find in Viefe the perfect decorative pieces to transform their spaces with the perfect design touch.

ES |

Nuestro ámbito de actuación es el mundo. Somos una marca con espíritu internacional, abierta a todos los estilos de vida y formas de entender la decoración. Nuestros productos están presentes en proyectos de arquitectura e interiorismo de los cinco continentes, donde profesionales y particulares encuentran en Viefe los complementos decorativos perfectos para transformar sus espacios con el toque óptimo de diseño.

CA |

El nostre àmbit d'actuació és el món. Som una marca amb esperit internacional, oberta a tots els estils de vida i maneres d'entendre la decoració. Els nostres productes són presents en projectes d'arquitectura i interiorisme dels cinc continents, on professionals i particulars troben en Viefe els complements decoratius perfectes per transformar els seus espais amb el toc òptim de disseny.

OUR LONG HISTORY

EN |

Viefe's origins lie in a button turnery, founded in 1932 in Sant Pere de Torelló (Barcelona). That small family business evolved into what today is a company specialising in the manufacture of decorative design accessories. In almost 100 years we have gone from fashion to decoration, always staying true to the style that defines us.

ES |

Los orígenes de Viefe están en una tornería de botones, fundada en 1932 en Sant Pere de Torelló (Barcelona), que ha evolucionado de ser un pequeño negocio familiar hasta convertirse en una empresa especializada en la fabricación de complementos decorativos de diseño. En casi 100 años hemos pasado de la moda a la decoración, conservando siempre el estilo que nos caracteriza.

CA |

Els orígens de Viefe són en una torneria de botons, fundada el 1932 a Sant Pere de Torelló (Barcelona), que ha evolucionat de ser un petit negoci familiar fins a convertir-se en una empresa especialitzada en la fabricació de complements decoratius de disseny. En gairebé 100 anys hem passat de la moda a la decoració, conservant sempre l'estil que ens caracteritza.

NATURE LOVERS

EN |

Our roots are closely linked to those of the great beech and oak forests that surround us, protected spaces that we love and are our welcome duty to preserve. That is why we adopt a culture of environmental awareness where we opt to use wood and organic materials, recycled paper and plastic packaging, 100% renewable energy and lower-than-average CO₂ emissions.

ES |

Nuestras raíces están estrechamente ligadas a los grandes bosques de haya y roble que nos rodean, espacios protegidos que queremos y tenemos el deber de preservar. Por eso, aplicamos una cultura de conciencia ambiental que nos lleva a apostar por la madera y los materiales orgánicos, utilizar packaging de papel y plásticos reciclados, funcionar con energías 100% renovables y tener un índice de emisiones en CO₂ por debajo de la media.

CA |

Les nostres arrels estan estretament lligades als grans boscos de faig i roure que ens envolten, espais protegits que estimem i tenim el deure de preservar. Per això, apliquem una cultura de consciència ambiental que ens porta a apostar per la fusta i els materials orgànics, fer servir packaging de paper i plàstics reciclats, funcionar amb energies 100% renovables i tenir un índex d'emissions en CO₂ per sota de la mitjana.

*We are part of the Ges Valley,
an area of extraordinary landscapes.*

Alexis Vivet | Spain

Balutto Associati | Italy

Frank Person | Germany

Héctor Diego | Spain

Ilja Huber | Germany

Johannes Lindner | Germany

Kaschkasch | Germany

Patricia Roig | Spain

Steffensen & Würtz | Denmark

Teruel & Paré | Spain

Viefe Studio | Spain

2j Design | Usa

OUT STANDING DESIGNERS

EN |

We collaborate with prestigious designers from around the globe to create cutting-edge decorative accessories. Their talent, visionary approach and aesthetic sensibility elevate the creative discourse of our brand, resulting in an end product that is truly remarkable. Our challenge is to bring what they envision to life.

ES |

Colaboramos con prestigiosos diseñadores de todo el mundo junto a los que damos forma a accesorios decorativos vanguardistas. Su talento, sus enfoques visionarios y su sensibilidad estética elevan el discurso creativo de nuestra marca y el resultado final de los productos. Nuestro reto consiste en hacer realidad lo que ellos sueñan.

CA |

Col·laborem amb prestigiosos dissenyadors de tot el món juntament amb els que donem forma a accessoris decoratius avantguardistes. El seu talent, els seus enfocaments visionaris i la seva sensibilitat estètica eleven el discurs creatiu de la nostra marca i el resultat final dels productes. El nostre repte consisteix en fer realitat allò que ells somien.

PRODUCTS IN BALANCE

EN |

The minimalism of the new collection is our way of going back to basics.

ES |

El minimalismo de la colección es nuestra forma de reivindicar lo esencial.

CA |

El minimalisme de la nova col·lecció és la nostra forma de reivindicar el que és essencial.



Brushed bronze
Bronce cepillado
L619

0676

BROOKLYN

ALUMINIUM

Designer: Steffensen & Würtz **NEW!**

Finishes Acabados

Polished nickel
Niquel brillo

Brushed black
Negro cepillado

Titanium black
Negro titanio

Brushed brass cava
Latón cava cepillado

NEW! Brushed bronze
Bronce cepillado

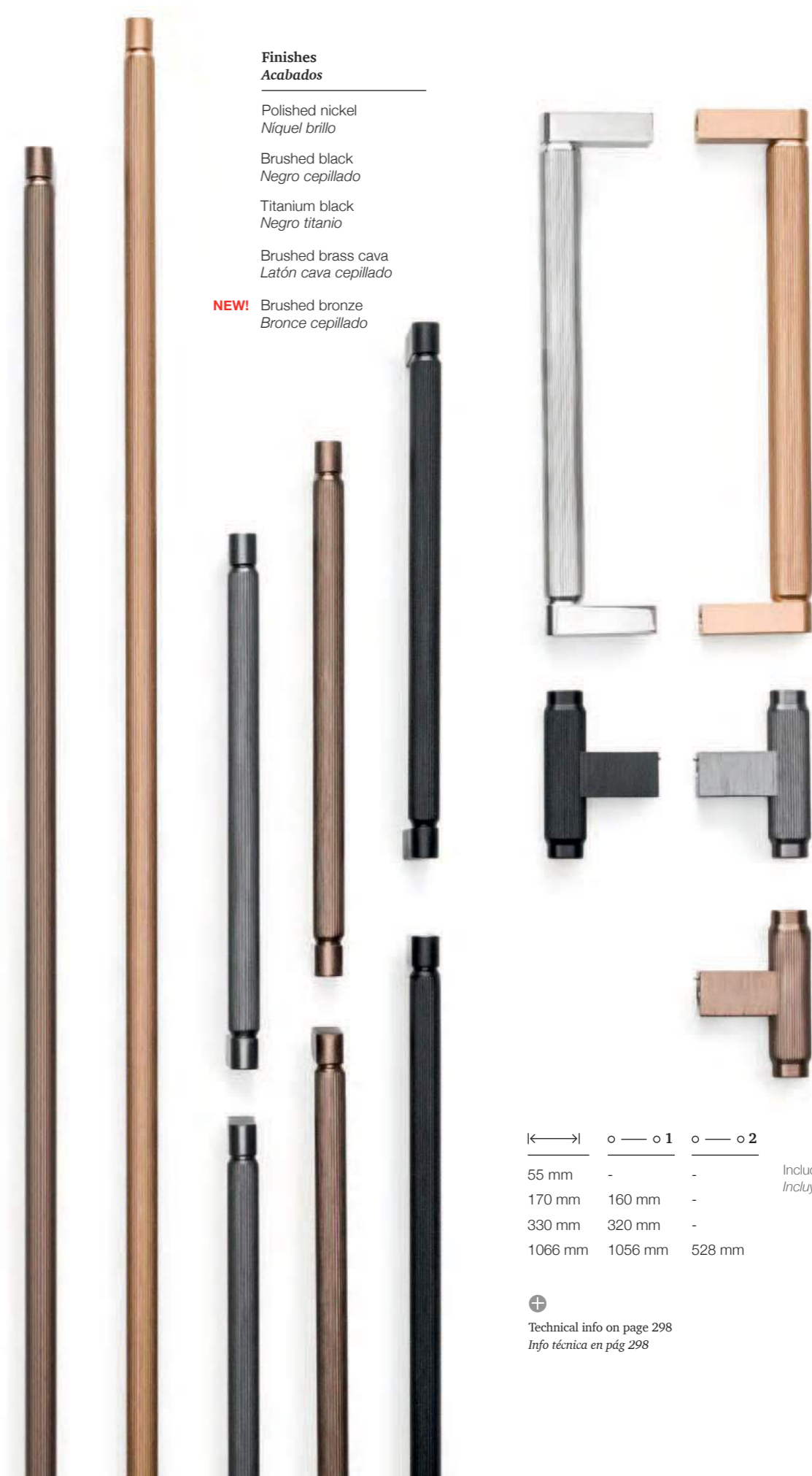

←→	o — o 1	o — o 2	
55 mm	-	-	Includes non-twisting tip <i>Incluye punta anti-giro</i>
170 mm	160 mm	-	
330 mm	320 mm	-	
1066 mm	1056 mm	528 mm	

⊕
Technical info on page 298
Info técnica en pág 298

0676

BROOKLYN

ALUMINIUM

Designer: Steffensen & Würtz **NEW!**



Polished nickel
Níquel brillo
L05

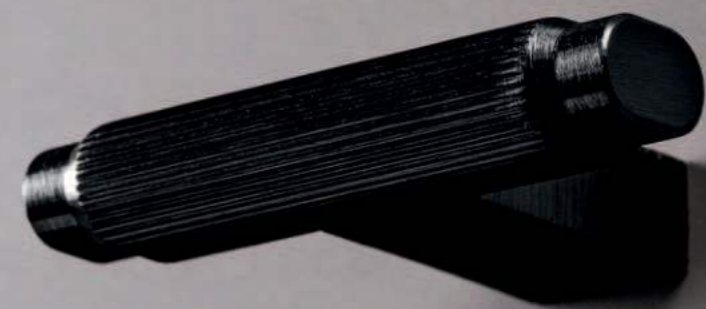

Titanium black
Negro titanio
L33



Titanium black
Negro titanio
L33

0677 / 0678 / 0679

BROOKLYN BIG

ALUMINIUM **NEW!**
Designer: Steffensen & Würtz

←→	○ — ○
466 mm	448 mm
1074 mm	1056 mm

①
Available with one side system
Disponible con sistema de una cara

②
Available with back to back system
Disponible con sistema de doble cara



Finishes Acabados

Polished nickel
Níquel brillo

Brushed black
Negro cepillado

Titanium black
Negro titanio

Brushed brass cava
Latón cava cepillado

NEW! Brushed bronze
Bronce cepillado

⊕
Technical info on page 299
Info técnica en pág 299

0677 / 0678 / 0679

BROOKLYN BIG

ALUMINIUM **NEW!**
Designer: Steffensen & Würtz



Titanium black
Negro titanio
L33



Brushed brass cava
Latón cava cepillado
L618



Textured metallic brown + Matt bronze
Marrón metal texturizado + Bronce mate
LMT4119

0700

CASEY

ALUMINIUM

Designer: Kaschkasch

NEW!

Finishes Acabados

- NEW!** Textured lava black + Matt black
Negro lava texturizado + Negro mate
- NEW!** Textured lava black + Polished titanium black
Negro lava texturizado + Negro titanio brillo
- NEW!** Textured metallic brown + Matt bronze
Marrón metal texturizado + Bronce mate

←→	o — o	
60 mm	-	Includes non-twisting tip <i>Incluye punta anti-giro</i>
211 mm	192 mm	
339 mm	320 mm	



⊕
 Technical info on page 304
Info técnica en pág 304



Textured metallic brown + Matt bronze
Marrón metal texturizado + Bronce mate
LMT4119

0701 / 0702 / 0703

CASEY BIG

ALUMINIUM

Designer: Kaschkasch

NEW!

Finishes Acabados

NEW! Textured lava black + Matt black
Negro lava texturizado + Negro mate

NEW! Textured lava black + Polished titanium black
Negro lava texturizado + Negro titanio brillo

NEW! Textured metallic brown + Matt bronze
Marrón metal texturizado + Bronce mate

←→	o — o
448 mm	416 mm
768 mm	736 mm

ⓘ Available with one side system
Disponible con sistema de una cara

Ⓜ Available with back to back system
Disponible con sistema de doble cara

⊕ Technical info on page 304
Info técnica en pág 304



0701 / 0702 / 0703

CASEY BIG

ALUMINIUM

Designer: Kaschkasch

NEW

Textured lava black + Polished titanium black
Negro lava texturizado + Negro titanio brillo
LMT2703

Textured lava black + Matt black
Negro lava texturizado + Negro mate
LMT2709



Titanium black
Negro titanio
Z33

0673

BEAM

ZAMAK

Designer: Johannes Lindner

NEW!

Finishes
Acabados

Brushed nickel
Níquel cepillado

Titanium black
Negro titanio

Brushed brass cava
Latón cava cepillado

Matt black
Negro mate



←→	o — o
104 mm	96 mm
168 mm	160 mm
328 mm	320 mm

⊕
 Technical info on page 297
Info técnica en pág 297



Polished nickel
Níquel brillo
Z05

0673

BEAM

ZAMAK

Designer: Johannes Lindner

NEW!

Finishes
Acabados

Polished titanium black
Negro titanio brillo

Polished nickel
Níquel brillo

Polished brass
Latón brillo

← →	o — o
104 mm	96 mm
168 mm	160 mm
328 mm	320 mm



Technical info on page 297
Info técnica en pág 297



Polished titanium black
Negro titanio brillo
Z03

0673

BEAM

ZAMAK

Designer: Johannes Lindner

NEW!



Matt black
Negro mate
ZM2



Brushed bronze
Bronce cepillado
L619

0686

HINOKI

ALUMINIUM

Designer: Alexis Vivet

NEW!



← → ○ — ○
60 mm - Includes non-twisting tip
220 mm 160 mm Incluye punta anti-giro

Finishes
Acabados

Brushed black
Negro cepillado

Brushed brass cava
Latón cava cepillado

NEW! Brushed bronze
Bronce cepillado

⊕
Technical info on page 300
Info técnica en pág 300



Brushed brass cava
Latón cava cepillado
L618

0687

HINOKI BIG

ALUMINIUM

Designer: Alexis Vivet

NEW!

Finishes
Acabados

Brushed black
Negro cepillado

Brushed brass cava
Latón cava cepillado

NEW! Brushed bronze
Bronce cepillado

←→	o — o 1	o — o 2
500 mm	416 mm	-
915 mm	832 mm	416 mm

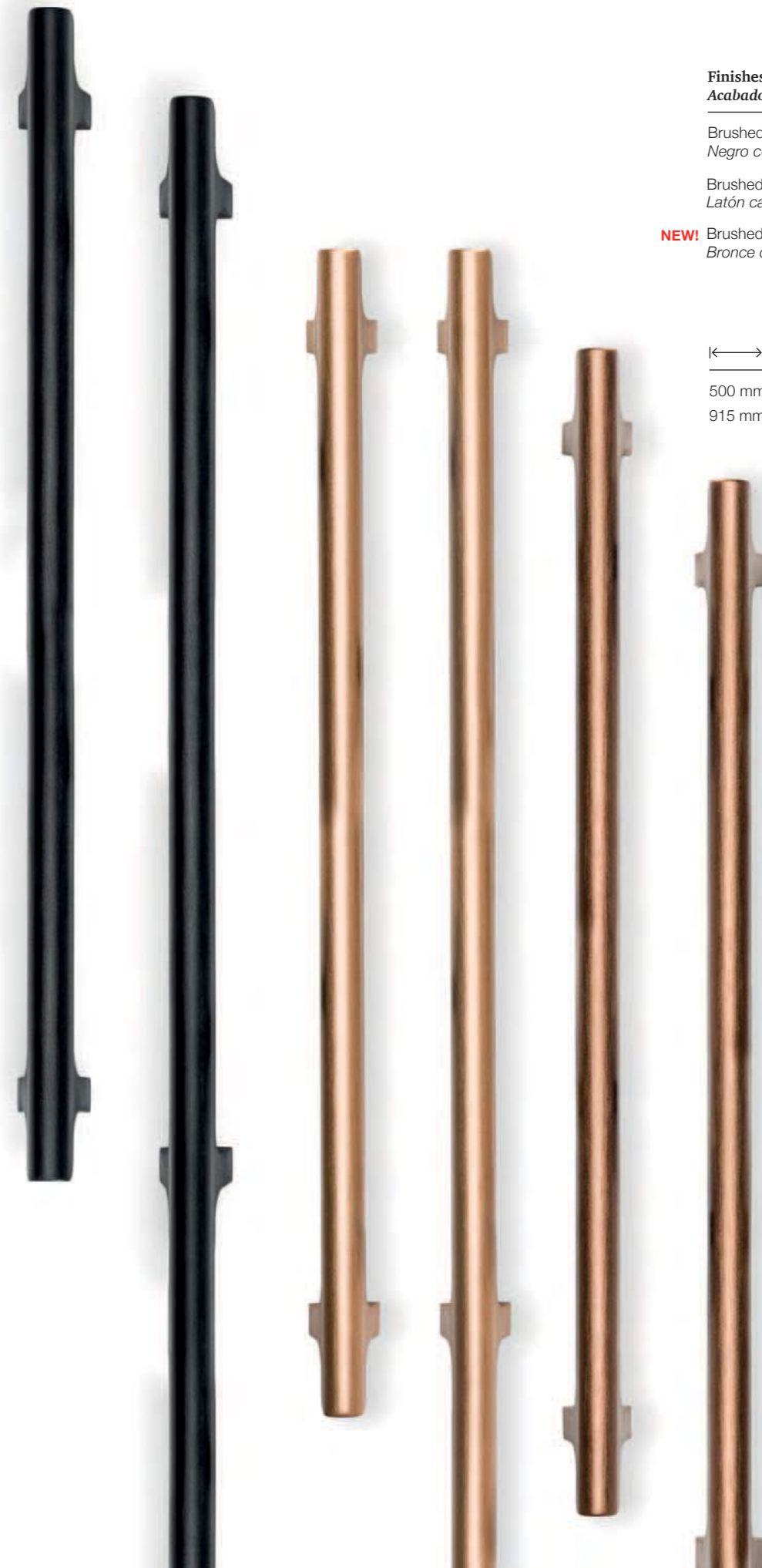

⊕
 Technical info on page 301
Info técnica en pág 301



Oak
Roble
W16

0681

HINOKI WOOD

WOOD

Designer: Alexis Vivet

NEW!

Finishes Acabados

-  Oak
Roble
-  Walnut
Nogal
-  Raw oak
Roble crudo

←→	o — o	
60 mm	-	Includes non-twisting tip
220 mm	160 mm	Incluye punta anti-giro



 Certified wood
Madera certificada

 Technical info on page 299
Info técnica en pág 299



Raw oak
 Roble crudo
 W00



0682

HINOKI WOOD BIG

WOOD

Designer: Alexis Vivet

NEW!

Finishes Acabados

Oak
 Roble

Walnut
 Nogal

Raw oak
 Roble crudo

←→	o — o 1	o — o 2
500 mm	416 mm	-
915 mm	832 mm	416 mm



Certified wood
 Madera certificada

Technical info on page 300
 Info técnica en pág 300



Oak
Roble
W16

0695

HAKO

WOOD



Designer: Steffensen & Würtz

NEW!

Finishes
Acabados

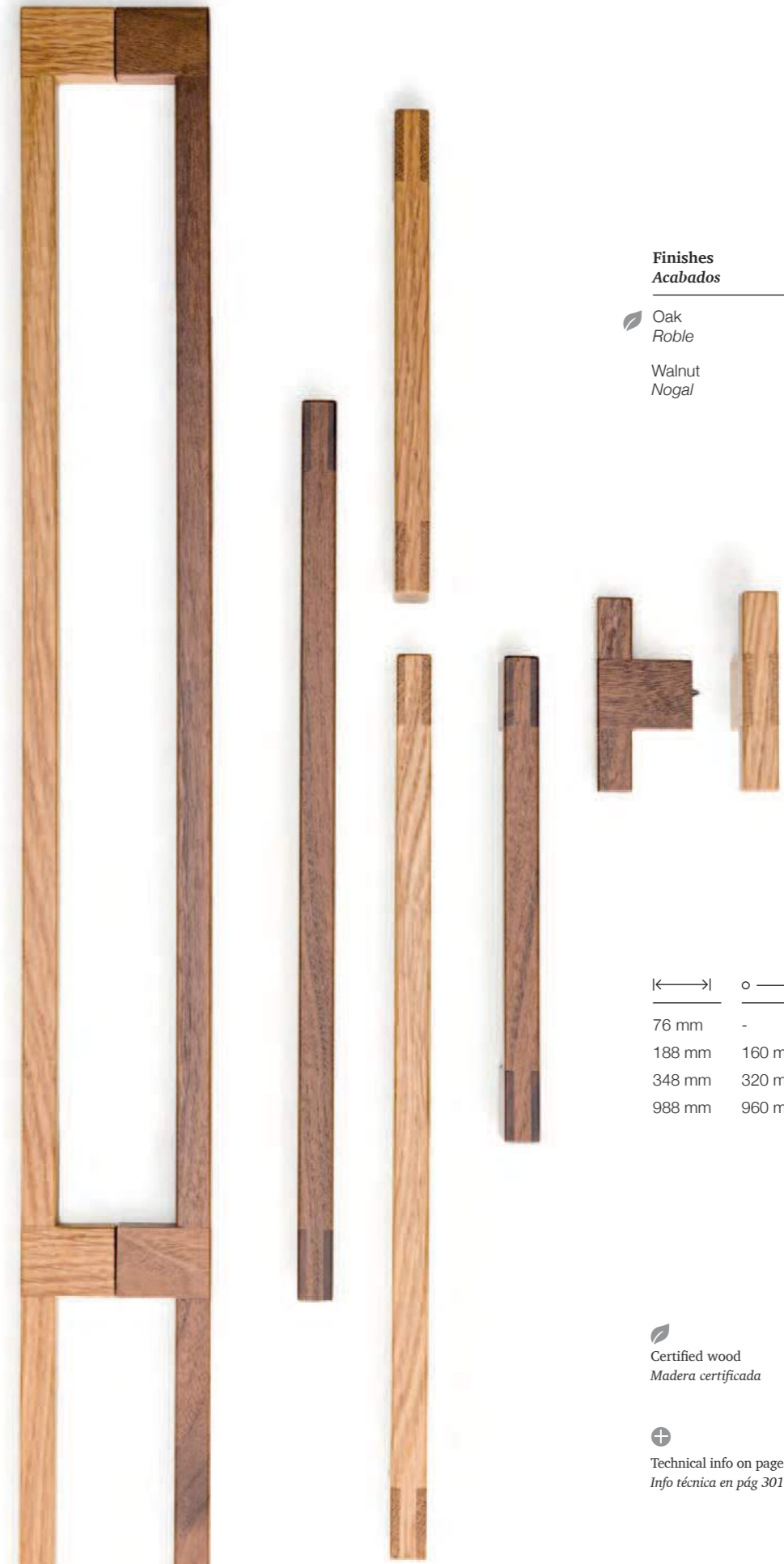
-  Oak
Roble
- Walnut
Nogal



	
76 mm	-
188 mm	160 mm
348 mm	320 mm
988 mm	960 mm

Includes non-twisting tip
Incluye punta anti-giro

 Certified wood
Madera certificada

 Technical info on page 301
Info técnica en pág 301



Walnut
Nogal
W17

0695

HAKO

WOOD

Designer: Steffensen & Würtz

NEW!





Walnut
Nogal
W17

0705 / 0706 / 0707

HAKO BIG

WOOD

Designer: Steffensen & Würtz **NEW!**





Finishes Acabados

-  Oak
Roble
- Walnut
Nogal

←→	o — o 1	o — o 2
525 mm	480 mm	-
1005 mm	960 mm	480 mm

 Available with one side system
Disponibile con sistema de una cara

 Available with back to back system
Disponibile con sistema de doble cara

 Certified wood
Madera certificada

 Technical info on page 302
Info técnica en pág 302

Oak
Roble
W16

0705 / 0706 / 0707

HAKO BIG

WOOD

Designer: Steffensen & Würtz

NEW!





Walnut
Nogal
W17

0698

CANO

WOOD

Designer: Kaschkasch

NEW!

Finishes Acabados

-  Oak
Roble
-  Walnut
Nogal
-  Oak matt black lacquered
Roble lacado negro mate
-  Raw oak
Roble crudo

←→	o — o 1	o — o 2
200 mm	160 mm	-
360 mm	320 mm	-
1100 mm	1024 mm	512 mm

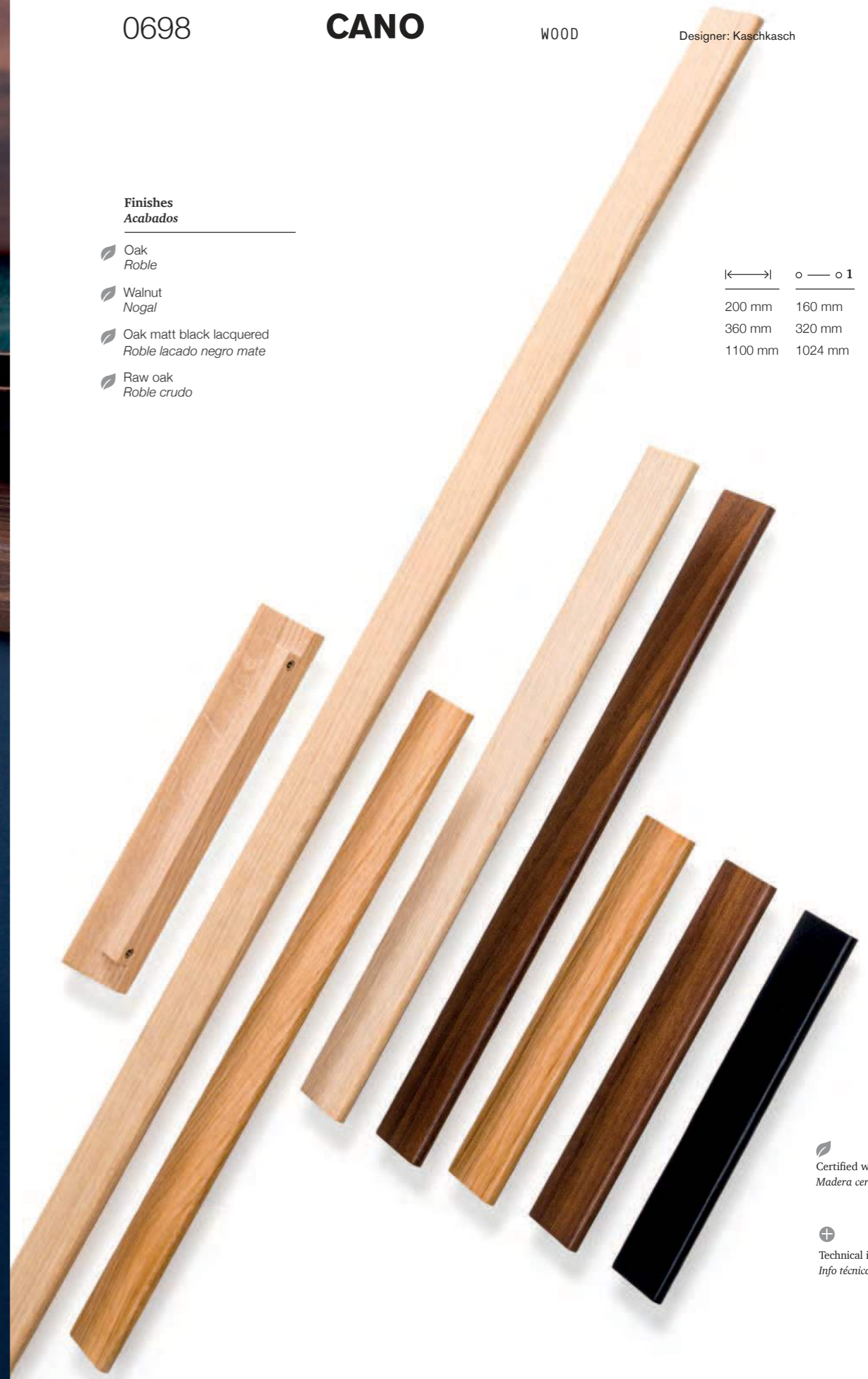

 Certified wood
Madera certificada

 Technical info on page 303
Info técnica en pág 303



0698

CANO

WOOD

Designer: Kaschkasch

NEW!



Raw oak
Roble crudo
W00



0674

PIECE

WOOD

Designer: Steffensen & Würtz

NEW!

Finishes
Acabados

- 🍃 Oak
Roble
- Walnut
Nogal
- 🍃 Oak matt black lacquered
Roble lacado negro mate



25,4 mm



Oak
Roble
W16

🍃
Certified wood
Madera certificada

⊕
Technical info on page 298
Info técnica en pág 298



Forest green
Verde forest
ZM31

0646

MILANO

ZAMAK

Designer: Kaschkasch

NEW!

Finishes
Acabados

Matt white
Blanco mate

Matt black
Negro mate

Moss grey
Gris musgo

Forest green
Verde forest

Volcano red
Rojo volcano

Midnight blue
Azul midnight

←→	o — o
121 mm	96 mm
185 mm	160 mm

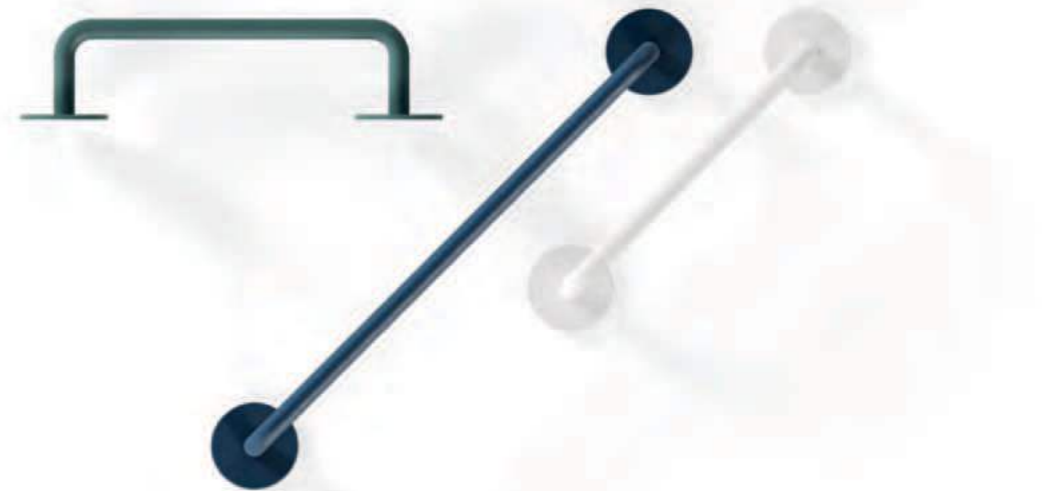
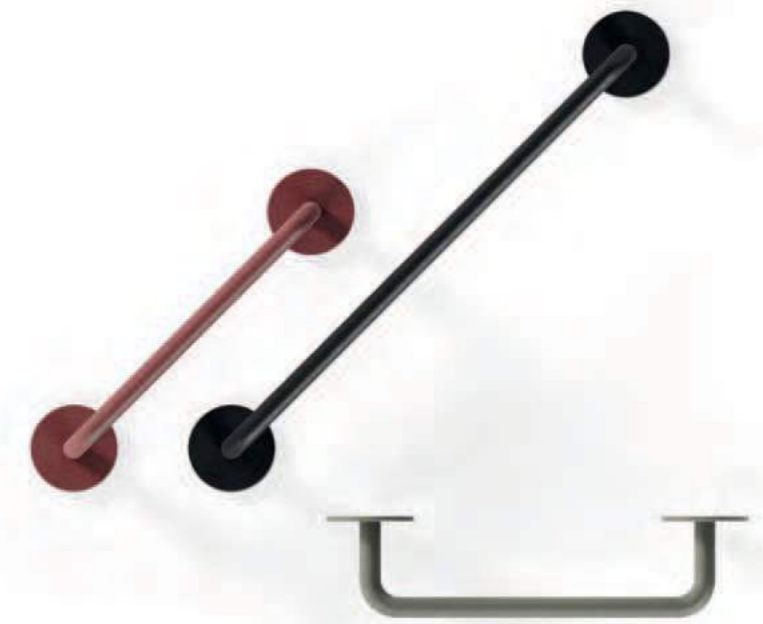

⊕
Technical info on page 296
Info técnica en pág 296

0666

SIX

ALUMINIUM

Designer: Viefe Studio

NEW!

Finishes
Acabados

- NEW!** Textured matt white
Blanco mate texturizado
- NEW!** Textured lava black
Negro lava texturizado
- NEW!** Textured metallic brown
Marrón metal texturizado



←→

- 147 mm
- 197 mm
- 247 mm
- 297 mm
- 347 mm
- 397 mm
- 447 mm
- 497 mm
- 597 mm
- 697 mm
- 797 mm
- 897 mm
- 997 mm
- 1197 mm
- 3000 mm *

*
Three metre profiles are delivered according to the units of the original packaging and cannot be sold separately.

Las barras de tres metros se sirven según las cantidades del embalaje original y no se pueden servir por separado.

⊕
Technical info on page 296
Info técnica en pág 296

Textured lava black
Negro lava texturizado
LMT27



Matt white
Blanco mate
LM1

0696

DROPP

ALUMINIUM

Designer: Ilja Huber

NEW!

Finishes

Acabados

Brushed nickel
Níquel cepillado

Matt white
Blanco mate

Matt black
Negro mate



←→	○ — ○
84 mm	64 mm
180 mm	160 mm

⊕
Technical info on page 302
Info técnica en pág 302



Brushed bronze
Bronce cepillado
L619

0628

MOON

ALUMINIUM

Designer: Ilja Huber

NEW!

Finishes
Acabados

Stainless steel look
Inox look

Brushed brass cava
Latón cava cepillado

Brushed black
Negro cepillado

NEW! Brushed bronze
Bronce cepillado

←→	o — o
193 mm	160 mm
353 mm	320 mm

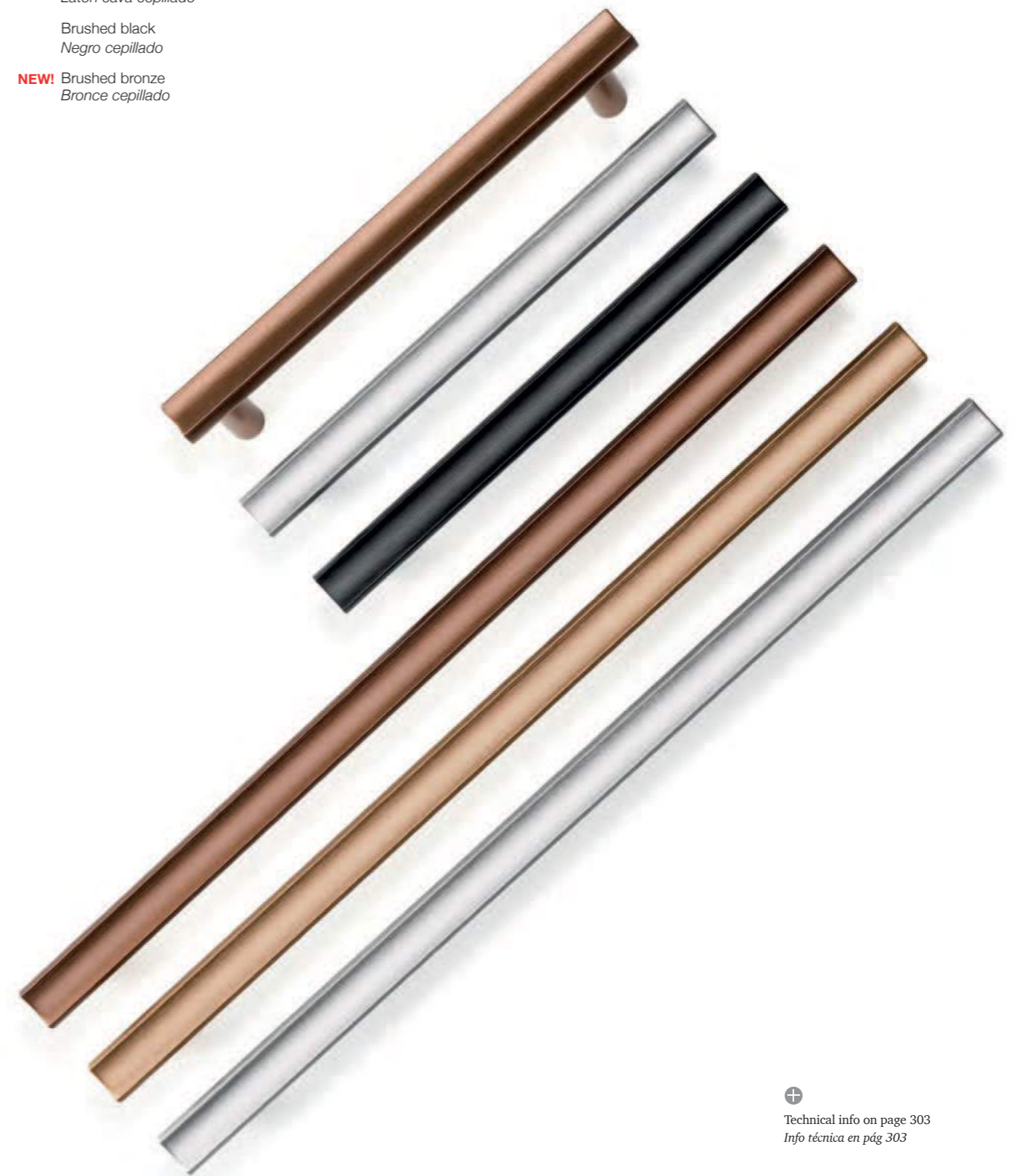

⊕
Technical info on page 303
Info técnica en pág 303



Brushed brass cava
Latón cava cepillado
L618

0629 / 0662 / 0663

MOON BIG

ALUMINIUM

Designer: Ilja Huber

Finishes
Acabados

Stainless steel look
Inox look

Brushed brass cava
Latón cava cepillado

Brushed black
Negro cepillado

NEW! Brushed bronze
Bronce cepillado



←→	○ — ○ 1	○ — ○ 2
424 mm	384 mm	-
1096 mm	1056 mm	528 mm

ⓘ Available with one side system
Disponible con sistema de una cara

Ⓜ Available with back to back system
Disponible con sistema de doble cara

⊕ Technical info on page 310
Info técnica en pág 310

0629 / 0662 / 0663

MOON BIG

ALUMINIUM

Designer: Iija Huber

Brushed brass cava
Latón cava cepillado
L618

Brushed black
Negro cepillado
L30



Walnut
Nogal
W17

0699

LUV WOOD

WOOD

Designer: Kaschkasch

NEW!



←→	o — o
51,2 mm	-
183 mm	160 mm

Includes non-twisting tip
Incluye punta anti-giro

Finishes Acabados

- 🌿 Oak
Roble
- Walnut
Nogal
- 🌿 Oak matt black lacquered
Roble lacado negro mate
- 🌿 Raw oak
Roble crudo

🌿 Certified wood
Madera certificada

⊕ Technical info on page 297
Info técnica en pág 297



Oak
Roble
W16





0664 / 0665 / 0671

LUV BIG

WOOD

Designer: Kaschkasch

Finishes Acabados

-  Oak
Roble
-  Walnut
Nogal
-  Oak matt black lacquered
Roble lacado negro mate
- NEW!**  Raw oak
Roble crudo

↳←→	○ — ○ 1	○ — ○ 2
418,5 mm	384 mm	-
1026,5 mm	992 mm	496 mm

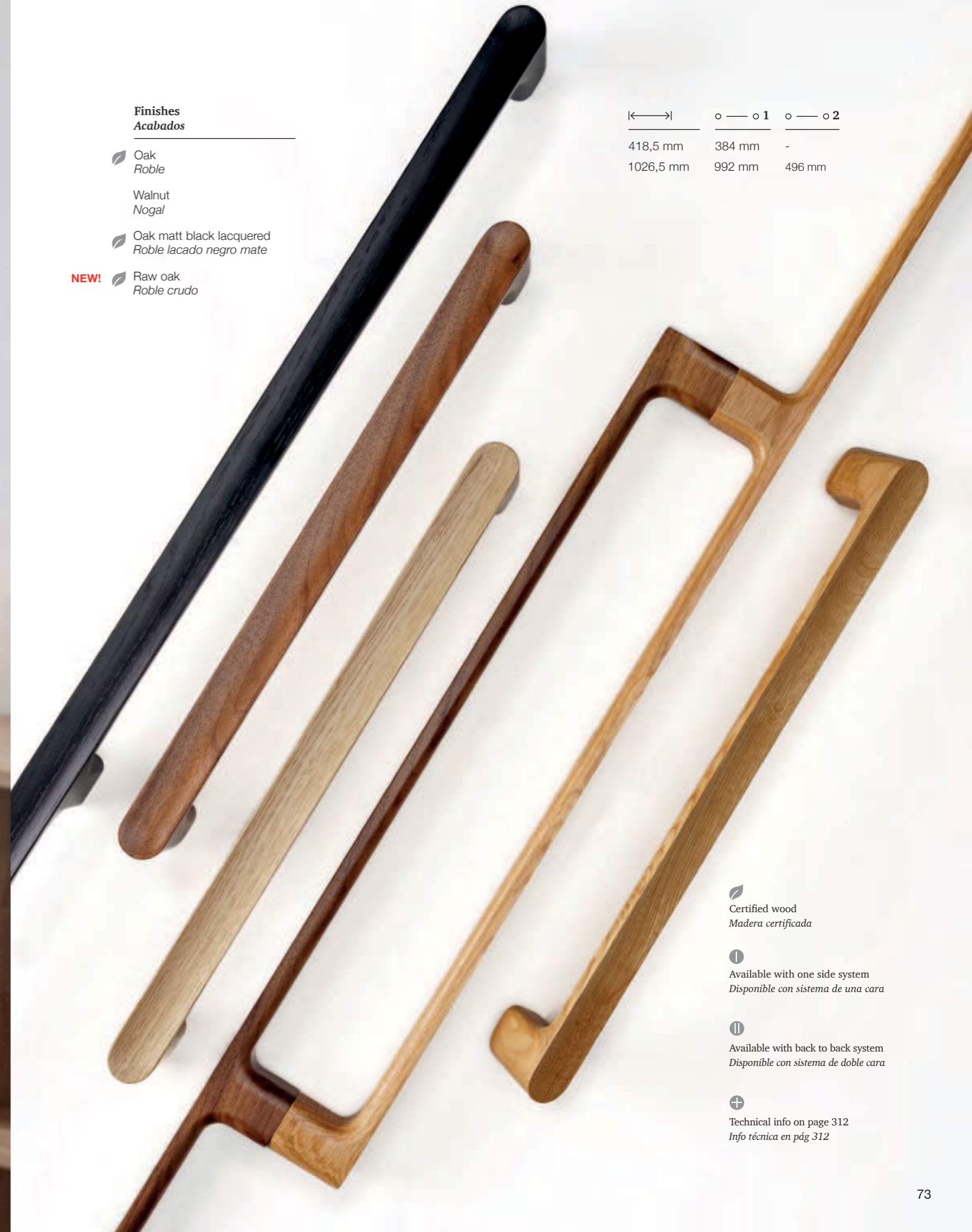

 Certified wood
Madera certificada

 Available with one side system
Disponible con sistema de una cara

 Available with back to back system
Disponible con sistema de doble cara

 Technical info on page 312
Info técnica en pág 312

0664 / 0665 / 0671

LUV BIG

WOOD

Designer: Kaschkasch



Walnut
Nogal
W17



Oak
Roble
W16



Matt black
Negro mate
ZM2

0536

LUV

ZAMAK

Designer: Kaschkasch

Finishes
Acabados

	←→	o — o	
Brushed nickel <i>Níquel cepillado</i>	51,2 mm	-	Includes non-twisting tip <i>Incluye punta anti-giro</i>
Brushed brass cava <i>Latón cava cepillado</i>	202 mm	192 mm	
	330 mm	320 mm	

Matt white
Bianco mate

Matt black
Negro mate



Technical info on page 312
Info técnica en pág 312

0375

VANN

ALUMINIUM

Designer: Alexis Vivet



Brushed bronze
 Bronce cepillado
L619



Finishes
Acabados

Anodized bright
 Anodizado brillo

Anodized matt
 Anodizado mate

Matt black
 Negro mate

Stainless steel look
 Inox look

Brushed dark brass
 Latón oscuro cepillado

NEW! Titanium black
 Negro titanio

NEW! Brushed bronze
 Bronce cepillado

NEW! Matt white
 Blanco mate

←→	o — o 1	o — o 2
100 mm	64 mm	-
200 mm	128 mm	-
350 mm	256 mm	-
1200 mm	1120 mm	384mm



Technical info on page 342
 Info técnica en pág 342



Titanium black
Negro titanio
L33

0636

POINT

ALUMINIUM

Designer: Patricia Roig

Finishes
Acabados

Brushed black
Negro cepillado

Titanium black
Negro titanio

Brushed brass cava
Latón cava cepillado

←→	o — o 1	o — o 2	
Ø 40 mm	-	-	
110 mm	-	-	Includes non-twisting tip / <i>Incluye punta anti-giro</i>
228 mm	192 mm	-	
356 mm	320 mm	-	
996 mm	960 mm	480mm	



Technical info on page 305
Info técnica en pág 305





Brushed black
Negro cepillado
L30

0636

POINT

ALUMINIUM

Designer: Patricia Roig



Brushed brass cava
Latón cava cepillado
L618



Titanium black
Negro titanio
Z33

0627

FUSION

ZAMAK

Designer: Ilja Huber

Finishes
Acabados

Titanium black
Negro titanio

Brushed brass cava
Latón cava cepillado

Matt black
Negro mate

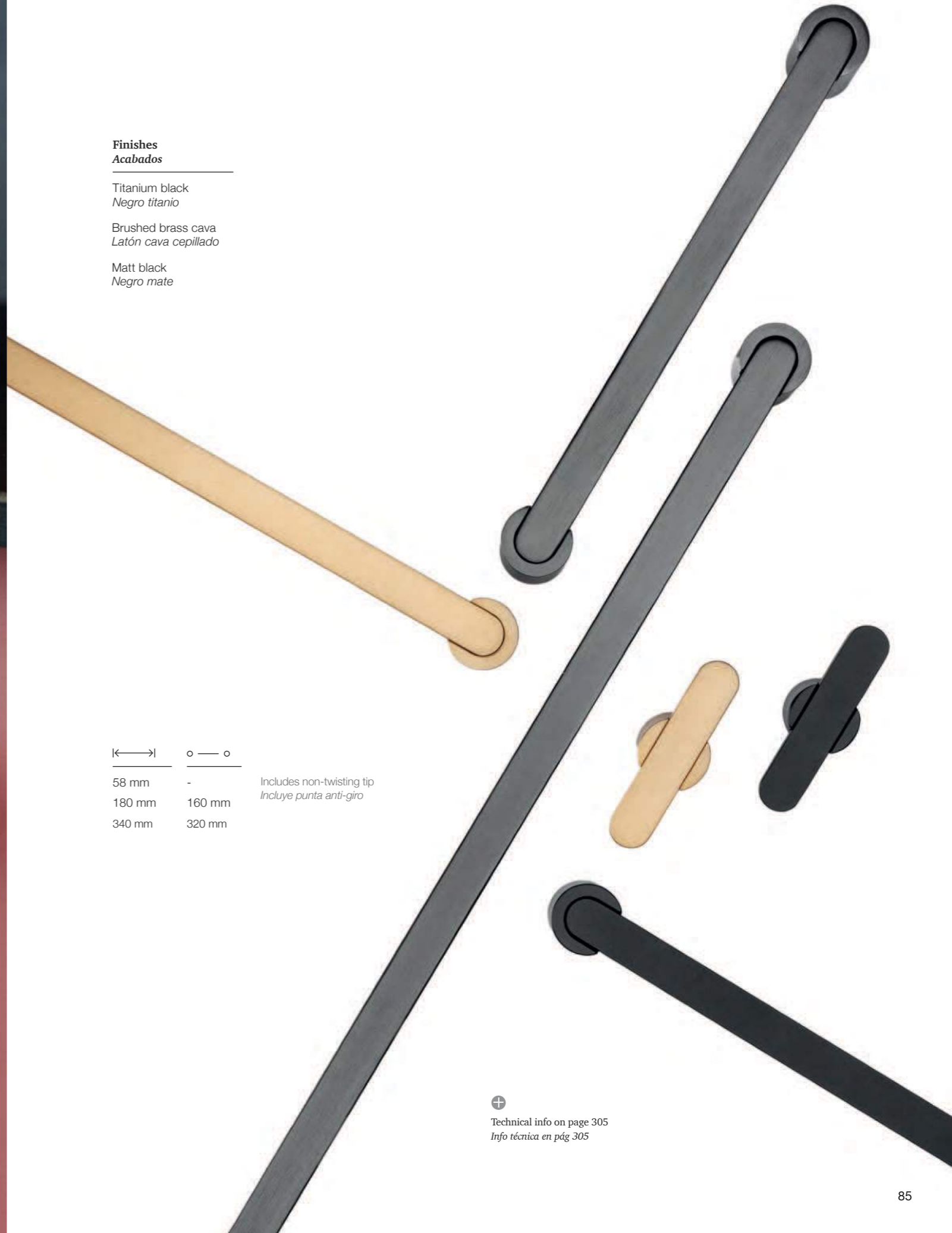

←→	o — o	
58 mm	-	
180 mm	160 mm	
340 mm	320 mm	

Includes non-twisting tip
Incluye punta anti-giro



Technical info on page 305
Info técnica en pág 305



Polished titanium black
Negro titanio brillo
Z03

0627

FUSION

ZAMAK

Designer: Ilja Huber



←→	o — o	
58 mm	-	Includes non-twisting tip <i>Incluye punta anti-giro</i>
180 mm	160 mm	
340 mm	320 mm	

Finishes
Acabados

Polished titanium black
Negro titanio brillo

Polished nickel
Níquel brillo

Polished brass
Latón brillo

⊕
 Technical info on page 305
Info técnica en pág 305



Titanium black
Negro titanio
Z33

0635

LIDD

ZAMAK

Designer: Ilja Huber

Finishes
Acabados

Brushed nickel
Níquel cepillado

Titanium black
Negro titanio

Brushed brass cava
Latón cava cepillado

Matt white
Blanco mate

Matt black
Negro mate

∅
64 mm



⊕
Technical info on page 306
Info técnica en pág 306



Polished titanium black
Negro titanio brillo
Z03

0638

PRISM

ZAMAK

Designer: Patricia Roig



Finishes
Acabados

- Titanium black
Negro titanio
- Brushed brass cava
Latón cava cepillado
- Matt white
Blanco mate
- Matt black
Negro mate
- Polished titanium black
Negro titanio brillo
- Polished nickel
Níquel brillo
- Polished brass
Latón brillo

←→
 32 mm

Includes non-twisting tip
Incluye punta anti-giro

⊕
 Technical info on page 306
Info técnica en pág 306



Brushed black
Negro cepillado
L30

0643

LINKK

ALUMINIUM

Designer: Alexis Vivet

Finishes
Acabados

Stainless steel look
Inox look

Brushed brass
Latón cepillado

Brushed black
Negro cepillado

←→	o — o 1	o — o 2
175 mm	160 mm	-
335 mm	320 mm	-
1071 mm	1056 mm	528 mm

⊕
Technical info on page 307
Info técnica en pág 307





Brushed brass
Latón cepillado
L291

0643

LINKK

ALUMINIUM

Designer: Alexis Vivet





Rustic brass
Latón rústico
Z623

0648

OMEGA

ZAMAK

Designer: Kaschkasch

Finishes
Acabados

Brushed brass cava
Latón cava cepillado

Rustic brass
Latón rústico

Matt black
Negro mate



← →	o — o
62,5 mm	32 mm
190,5 mm	160 mm

⊕
Technical info on page 307
Info técnica en pág 307



Brushed brass cava
Latón cava cepillado
Z618

0650

MOULE

ZAMAK

Designer: Kaschkasch

Finishes

Acabados

Titanium black
Negro titanio

Brushed brass cava
Latón cava cepillado

Matt white
Blanco mate

Matt black
Negro mate

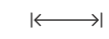

154 mm



Technical info on page 308
Info técnica en pág 308



Brushed brass cava
Latón cava cepillado
Z618

0603

LIPP

ZAMAK

Designer: Alexis Vivet



Finishes
Acabados

Brushed brass cava
Latón cava cepillado

Matt black
Negro mate

←→	o — o
205 mm	192 mm
333 mm	320 mm

⊕
 Technical info on page 308
Info técnica en pág 308



Moss grey
Gris musgo
LM25

0645

RISS

ALUMINIUM

Designer: Kaschkasch

Finishes
Acabados

Matt white
Blanco mate

Matt black
Negro mate

Moss grey
Gris musgo

Forest green
Verde forest

Mocca brown
Marrón mocca

Volcano red
Rojo volcano

Midnight blue
Azul midnight



Technical info on page 309
Info técnica en pág 309

←→	o — o	∅
207 mm	192 mm	15 mm
335 mm	320 mm	15 mm



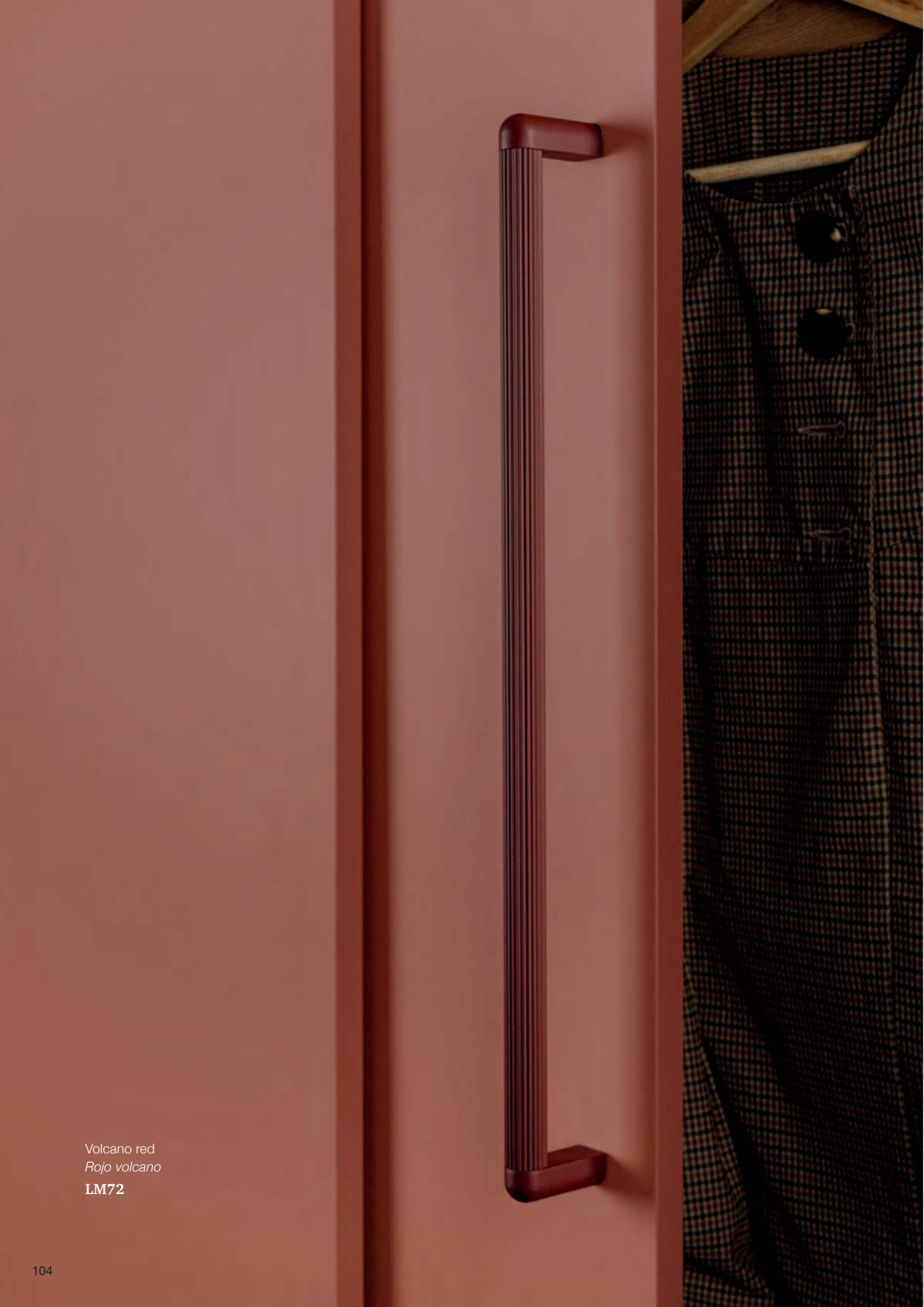

Volcano red
Rojo volcano
LM72

0655

RISS BIG

ALUMINIUM

Designer: Kaschkasch

Finishes
Acabados

Matt white
Blanco mate

Matt black
Negro mate

Moss grey
Gris musgo

Forest green
Verde forest

Mocca brown
Marrón mocca

Volcano red
Rojo volcano

Midnight blue
Azul midnight



←→	o — o 1	o — o 2	∅
502 mm	480 mm	-	20 mm
982 mm	960 mm	480 mm	20 mm



Technical info on page 309
Info técnica en pág 309



Brushed black
Negro cepillado
L30

0657

NOBB

ALUMINIUM

Designer: Viefe Studio

←→	o — o 1	o — o 2	
52 mm	-	-	Includes non-twisting tip / Incluye punta anti-giro
244 mm	192 mm	-	
372 mm	320 mm	-	
1108 mm	1056 mm	528mm	

Finishes
Acabados

Stainless steel look
Inox look

Brushed brass cava
Laton cava cepillado

Brushed black
Negro cepillado



⊕
Technical info on page 310
Info técnica en pág 310

0657

NOBB

ALUMINIUM

Designer: Viefe Studio

Brushed brass cava
Latón cava cepillado
L618

Stainless steel look
Inox look
L24



Lava black + Oak
 Negro lava + Roble
 NM2716

0658



DUO

ALUMINIUM + WOOD

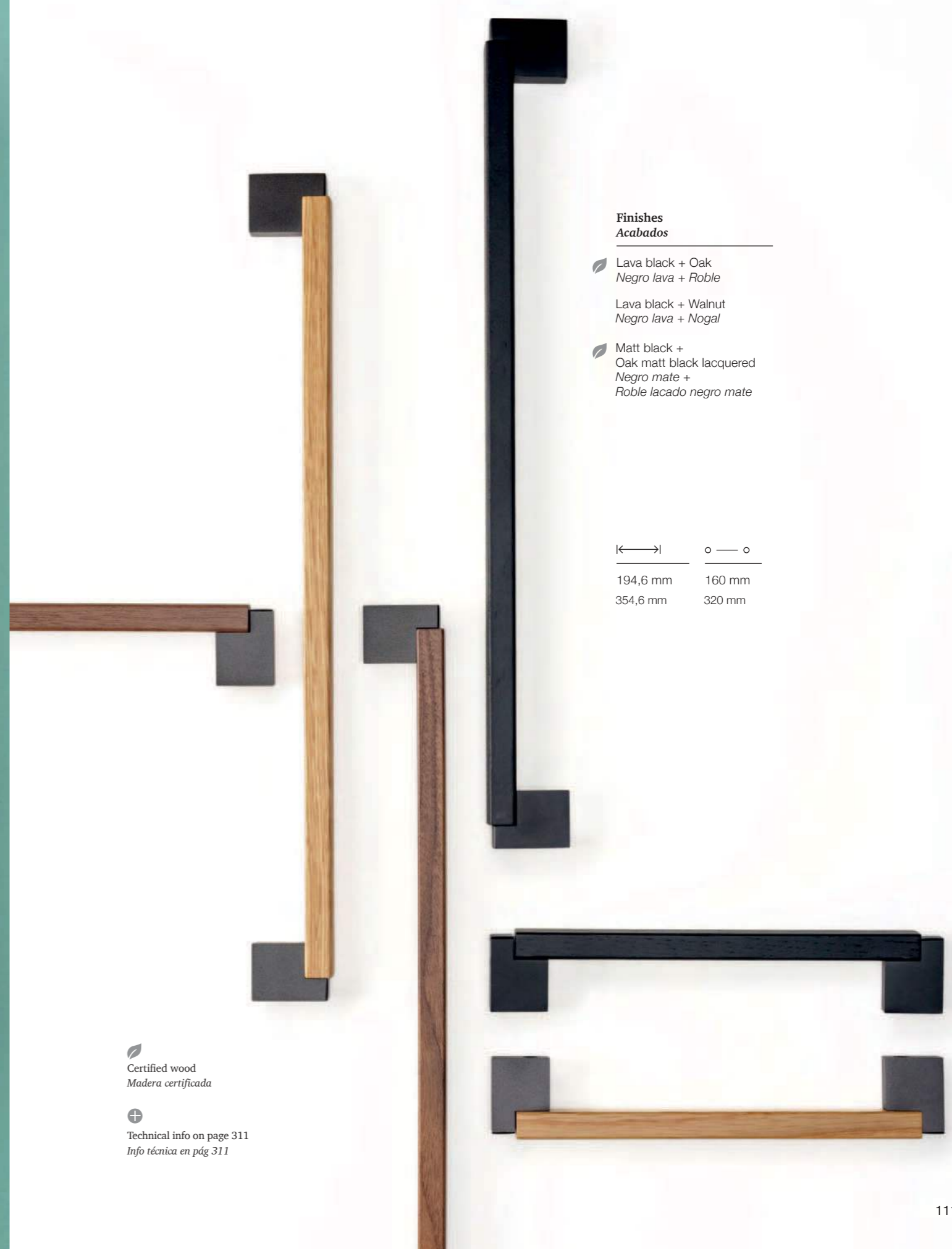
Designer: Ilja Huber



Finishes
Acabados



-  Lava black + Oak
 Negro lava + Roble
-  Lava black + Walnut
 Negro lava + Nogal
-  Matt black +
 Oak matt black lacquered
 Negro mate +
 Roble lacado negro mate

K →	o — o
194,6 mm	160 mm
354,6 mm	320 mm

 Certified wood
 Madera certificada

 Technical info on page 311
 Info técnica en pág 311

Finishes
Acabados

-  Lava black + Oak
Negro lava + Roble
-  Lava black + Walnut
Negro lava + Nogal
-  Matt black + Oak matt black lacquered
Negro mate + Roble lacado negro mate

←→	o — o 1	o — o 2
536 mm	480 mm	-
1016 mm	960 mm	480 mm

Lava black + Walnut
Negro lava + Nogal
NM2717

 Certified wood
Madera certificada

 Available with one side system
Disponible con sistema de una cara

 Available with back to back system
Disponible con sistema de doble cara

 Technical info on page 311
Info técnica en pág 311



Brushed brass
Latón cepillado
L291

0621

RILLE MINI

ALUMINIUM

Designer: Patricia Roig

Finishes
Acabados

- Polished nickel
Níquel brillo
- Stainless steel look
Inox look
- Brushed brass
Latón cepillado
- Brushed black
Negro cepillado

←→	o — o	
55 mm	-	
190 mm	160 mm	
350 mm	320 mm	

Includes non-twisting tip
Incluye punta anti-giro



Technical info on page 313
Info técnica en pág 313



Brushed brass
Latón cepillado
L291

0528

RILLE

ALUMINIUM

Designer: Patricia Roig



Finishes
Acabados

Stainless steel look
Inox look

Brushed brass
Latón cepillado

Brushed black
Negro cepillado

←→	○ — ○ 1	○ — ○ 2	
----	---------	---------	--

55 mm	-	-	Includes non-twisting tip <i>Incluye punta anti-giro</i>
190 mm	160 mm	-	
350 mm	320 mm	-	
510 mm	480 mm	-	
1022 mm	992 mm	496 mm	

⊕
Technical info on page 313
Info técnica en pág 313



Brushed brass cava
Latón cava cepillado
Z618

0487

PURA

ZAMAK

Designer: Balutto Associati

Finishes
Acabados

Polished chrome
Cromo brillo

Polished titanium black
Negro titanio brillo

Polished copper
Cobre brillo

Polished brass
Latón brillo

Brushed nickel
Níquel cepillado

Brushed brass cava
Latón cava cepillado

Matt black
Negro mate

←→	o — o
168 mm	160 mm
264 mm	256 mm

⊕
Technical info on page 314
Info técnica en pág 314

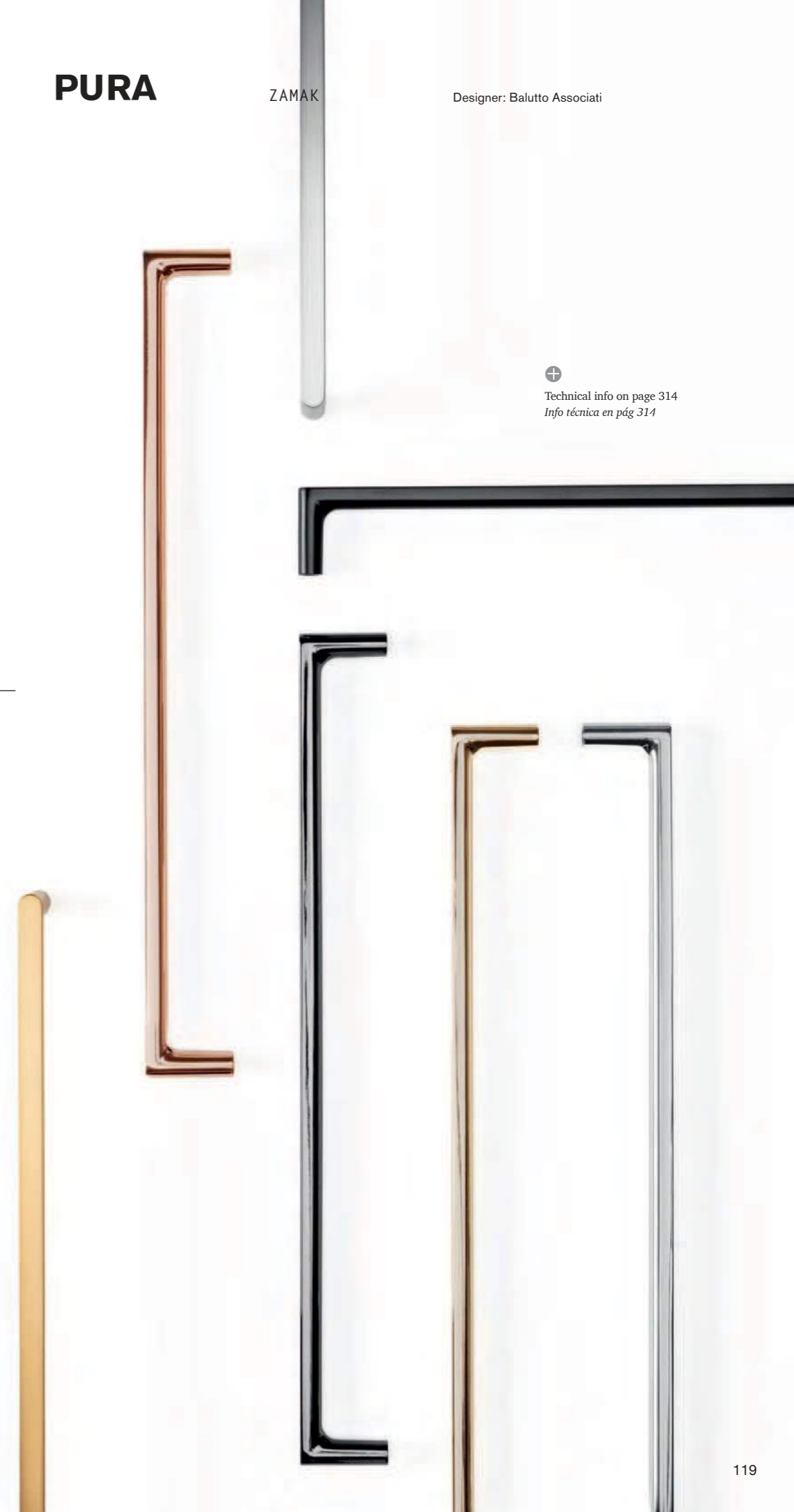



Volcano red
Rojo volcano
ZM72

0590

BELT

ZAMAK

Designer: Kaschkasch



Finishes
Acabados

Matt white
Blanco mate

Matt black
Negro mate

Moss grey
Gris musgo

Forest green
Verde forest

Mocca brown
Marrón mocca

Volcano red
Rojo volcano

←→	o — o	Includes non-twisting tip <i>Incluye punta anti-giro</i>
63,5 mm	-	
221,3 mm	160 mm	

⊕
Technical info on page 314
Info técnica en pág. 314



Forest green
Verde forest
ZM31



0590

BELT

ZAMAK

Designer: Kaschkasch

Finishes Acabados

Matt white
Blanco mate

Matt black
Negro mate

Moss grey
Gris musgo

Forest green
Verde forest

Mocca brown
Marrón mocca

Volcano red
Rojo volcano

$\leftarrow \rightarrow$ 63,5 mm 221,3 mm	$\circ \text{---} \circ$ - 160 mm	Includes non-twisting tip Incluye punta anti-giro
---	---	--



⊕
Technical info on page 314
Info técnica en pág. 314



Metal grey
Gris metal
ZM23

0597

PLIÉ

ZAMAK

Designer: Teruel & Paré

Finishes
Acabados

Matt black
Negro mate

Metal grey
Gris metal

Metal brown
Marrón metal

←→	○ — ○
114 mm	64 mm
210 mm	160 mm



⊕
Technical info on page 315
Info técnica en pág. 315



Antique bronze
Bronce antiguo
L613

0600

WING

ALUMINIUM

Designer: Alexis Vivet

Finishes Acabados	↳ — ↳	○ — ○ 1	○ — ○ 2
Stainless steel look <i>Inox look</i>	100 mm	64 mm	-
	200 mm	128 mm	-
Brushed black <i>Negro cepillado</i>	350 mm	256 mm	-
	1200 mm	1120 mm	384 mm
Antique bronze <i>Bronce antiguo</i>			
Brushed brass cava <i>Latón cava cepillado</i>			



Technical info on page 315
Info técnica en pág. 315

0600

WING

ALUMINIUM

Designer: Alexis Vivet



Brushed black
Negro mate
L30



Brushed brass cava
Latón cava cepillado
L618



Brushed black
Negro mate
L30

0610

FLAPP

ALUMINIUM

Designer: Frank Person

Finishes
Acabados

Stainless steel look
Inox look

Brushed black
Negro cepillado

Brushed brass cava
Latón cava cepillado

	←→	o — o 1	o — o 2
Stainless steel look	70 mm	32 mm	-
Brushed black	200 mm	128 mm	160 mm
Brushed brass cava	350 mm	256 mm	-
	1100 mm	416 mm	1056 mm



Technical info on page 316
Info técnica en pág. 316





Oak
 Roble
 W16

0613

FLAPP WOOD

WOOD

Designer: Frank Person



Finishes
Acabados

Oak
 Roble

Walnut
 Nogal

Oak raw
 Roble crudo

←→	o — o 1	o — o 2
70 mm	32 mm	-
200 mm	160 mm	-
1100 mm	1056 mm	416 mm



Technical info on page 317
 Info técnica en pág. 317





Walnut
Nogal
W17

0613

FLAPP WOOD

WOOD

Designer: Frank Person



Oak
Roble
W16



Lava black + Oak
 Negro lava + Roble
NM2716

0591

ETO

ALUMINIUM + WOOD

Designer: Kaschkasch



Technical info on page 316
 Info técnica en pág 316



Finishes
Acabados

Lava black + Oak
 Negro lava + Roble

Lava black + Walnut
 Negro lava + Nogal

Matt black + Ash matt black lacquered
 Negro mate + Fresno lacado negro mate

←→	o — o 1	o — o 2
174,6 mm	160 mm	-
334,6 mm	320 mm	-
1006,6 mm	992 mm	496 mm





0591

ETO

ALUMINIUM + WOOD

Designer: Kaschkasch



Lava black + Walnut
Negro lava + Nogal
NM2717



Lava black + Oak
Negro lava + Roble
NM2716





0601

OH!

WOOD

Designer: Alexis Vivet

Finishes
Acabados

Oak
Roble

Walnut
Nogal

Ash matt black lacquered
Fresno lacado negro mate



40 mm



Oak
Roble
W16



Technical info on page 317
Info técnica en pág. 317



Brushed brass cava
Latón cava cepillado
Z618

0601

OH!

ZAMAK

Designer: Alexis Vivet

Finishes
Acabados

Brushed nickel
Níquel cepillado

Brushed brass cava
Latón cava cepillado

Matt black
Negro mate



40 mm



Technical info on page 318
Info técnica en pág 318



Matt black
Negro mate
ZM2

0602

VALLEY

ZAMAK

Designer: Alexis Vivet

Finishes
Acabados

Polished titanium black
Negro titanio brillo

Polished brass
Latón brillo

Matt black
Negro mate

Brushed brass cava
Latón cava cepillado

K → I	o — o
223 mm	160 mm
330 mm	256 mm



⊕
Technical info on page 318
Info técnica en pág 318



Polished titanium black
Negro titanio brillo
Z03

0602

VALLEY

ZAMAK

Designer: Alexis Vivet



Finishes
Acabados

Polished titanium black
Negro titanio brillo

Polished brass
Latón brillo

Matt black
Negro mate

Brushed brass cava
Latón cava cepillado

←→	○ — ○
223 mm	160 mm
330 mm	256 mm

⊕
 Technical info on page 318
Info técnica en pág 318



Polished titanium black
Negro titanio brillo
Z03

0614

EQUIS

ZAMAK

Designer: Patricia Roig



Finishes
Acabados

- Polished chrome
Cromo brillo
- Polished titanium black
Negro titanio brillo
- Polished copper
Cobre brillo
- Polished brass
Latón brillo
- Matt white
Blanco mate
- Matt black
Negro mate

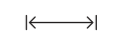

40 mm



Technical info on page 319
Info técnica en pág 319



Matt black
Negro mate
ZM2

0604

PRISMA

ZAMAK

Designer: Alexis Vivet

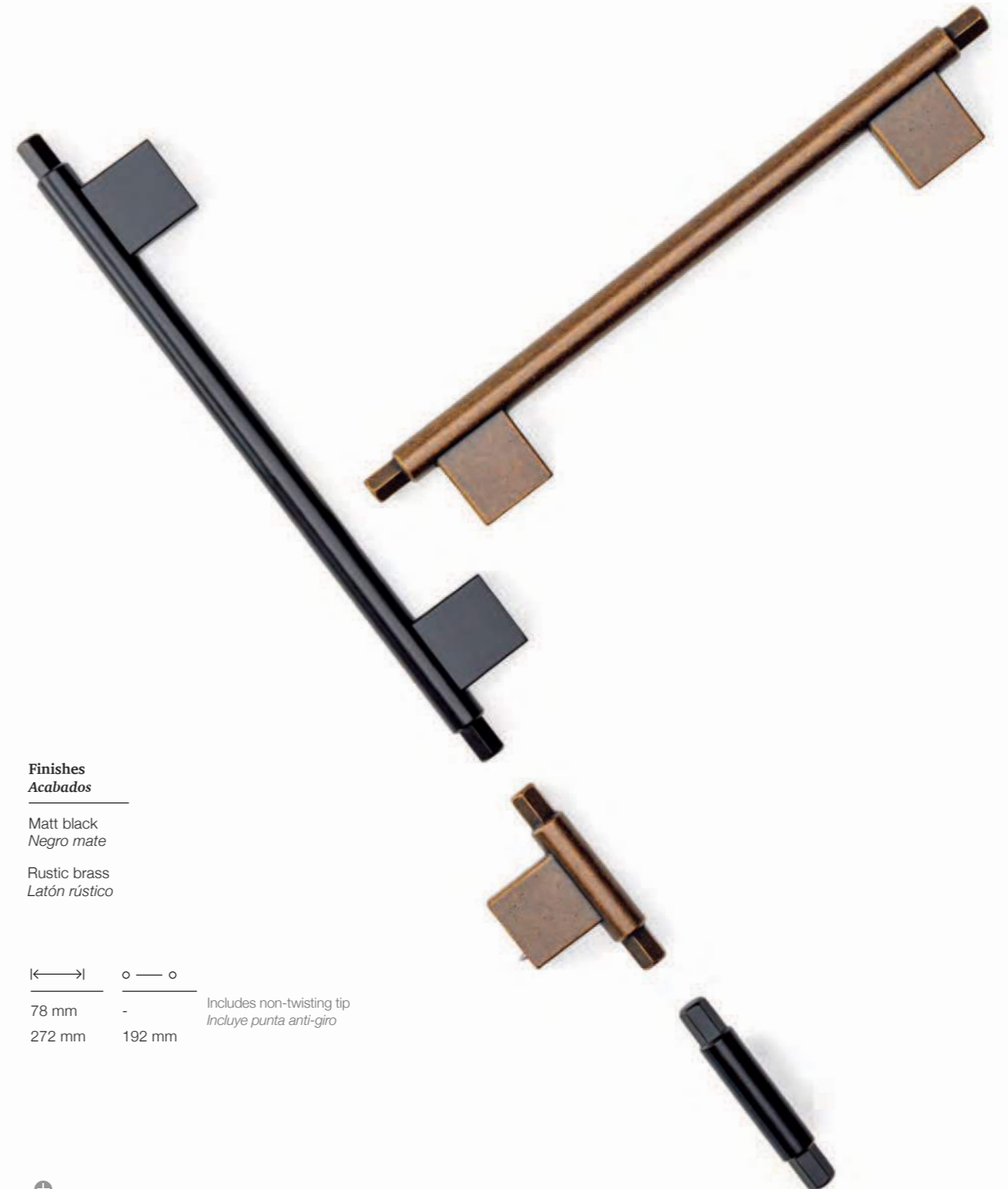

Finishes
Acabados

Matt black
Negro mate

Rustic brass
Latón rústico

↳ —	o — o	
78 mm	-	Includes non-twisting tip <i>Incluye punta anti-giro</i>
272 mm	192 mm	

⊕
 Technical info on page 318
Info técnica en pág 318



Brushed brass cava
Latón cava cepillado
Z618

0608

QUART MINI

ZAMAK

Designer: Frank Person

Finishes
Acabados

Brushed brass cava
Latón cava cepillado

Rustic brass
Latón rústico

Matt black
Negro mate

←→	o — o	
26 mm	-	Includes non-twisting tip <i>Incluye punta anti-giro</i>
146 mm	128 mm	



⊕
 Technical info on page 319
Info técnica en pág. 319



Rustic brass
Latón rústico
Z623

0616

QUART

ZAMAK

Designer: Frank Person



Finishes
Acabados

Brushed brass cava
Latón cava cepillado

Rustic brass
Latón rústico

Matt black
Negro mate

←→	o — o	
33,8 mm	-	Includes non-twisting tip <i>Incluye punta anti-giro</i>
183,4 mm	160 mm	

⊕
 Technical info on page 319
Info técnica en pág 319



Rustic brass
Latón rústico
L623

0588

ARPA PLATE

ALUMINIUM

Designer: Viefe Studio

Finishes
Acabados

Stainless steel look
Inox look
 Brushed brass
Latón cepillado
 Brushed black
Negro cepillado
 Rustic brass
Latón rústico

←→	o	o 1	o	o 2
Ø 22 mm	-	-	-	-
70 mm	-	-	-	-
230 mm	192 mm	-	-	-
358 mm	320 mm	-	-	-
1216 mm	1178 mm	589 mm	-	-

⊕
 Technical info on page 323
 Info técnica en pág 323

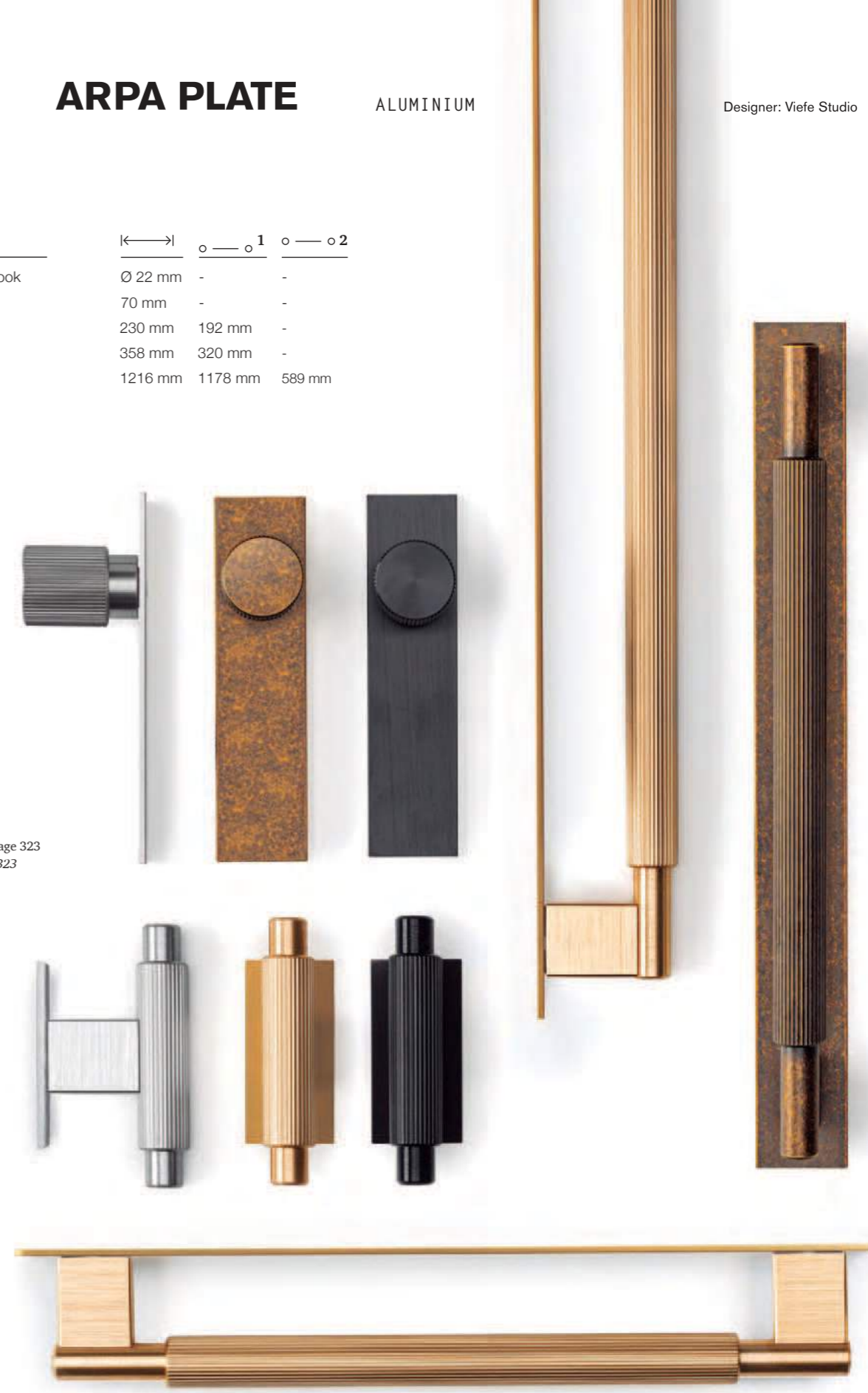

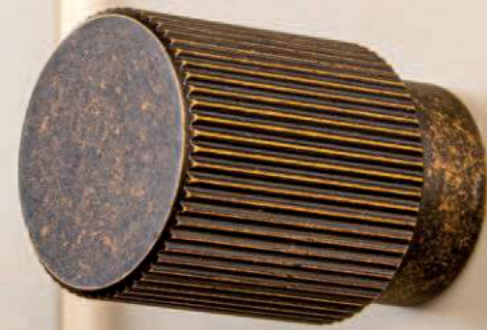

Rustic brass
Latón rústico
L623

0583

ARPA

ALUMINIUM

Designer: Viefé Studio

Finishes
Acabados

Stainless steel look
Inox look

Brushed brass
Latón cepillado

Brushed black
Negro cepillado

Rustic brass
Latón rústico

←→	o — o 1	o — o 2	
Ø 22 mm	-	-	
70 mm	-	-	Includes non-twisting tip <i>Incluye punta anti-giro</i>
214 mm	192 mm	-	
342 mm	320 mm	-	
1200 mm	1178 mm	589 mm	



⊕
Technical info on page 324
Info técnica en pág 324





Textured black
Negro texturizado
ZM22

0506

FIRM

ZAMAK

Designer: Frank Person

Finishes
Acabados

Textured black
Negro texturizado

←→	o — o
45,8 mm	-
93,8 mm	64 mm
93,8 mm	64 mm
125,8 mm	96 mm
189,8 mm	160 mm
349,8 mm	320 mm

Cup pull / Tirador concha



Technical info on page 332
Info técnica en pág 332



Textured black
Negro texturizado
ZM22



0506

FIRM

ZAMAK

Designer: Frank Person

Textured black
Negro texturizado
ZM22



Oak
Roble
W16

0530

DISC

WOOD

Designer: Balutto Associati



Finishes
Acabados

Oak
Roble

Walnut
Nogal

Ash matt black lacquered
Fresno lacado negro mate

Raw oak
Roble crudo



38 mm
50 mm



Technical info on page 320
Info técnica en pág. 320



Brushed brass cava
Latón cava cepillado
Z618

0530

DISC

ZAMAK

Designer: Balutto Associati



Finishes
Acabados

Brushed nickel
Níquel cepillado

Brushed brass cava
Latón cava cepillado

Matt white
Blanco mate

Matt black
Negro mate



38 mm
50 mm



Technical info on page 320
Info técnica en pág. 320



Walnut
Nogal
W17

0538

CONIC

WOOD

Designer: Kaschkasch



Finishes
Acabados

Oak
Roble

Walnut
Nogal

Ash matt black lacquered
Fresno lacado negro mate



29,4 mm
43 mm



Technical info on page 320
Info técnica en pág. 320



Matt black
Negro mate
ZM2

0538

CONIC

ZAMAK

Designer: Kaschkasch



Finishes
Acabados

Matt white
Blanco mate

Matt black
Negro mate

Moss grey
Gris musgo



29,4 mm
43 mm



Technical info on page 321
Info técnica en pág 321



Matt black
Negro mate
ZM2

0542

FOLD

ZAMAK

Designer: Teruel & Paré

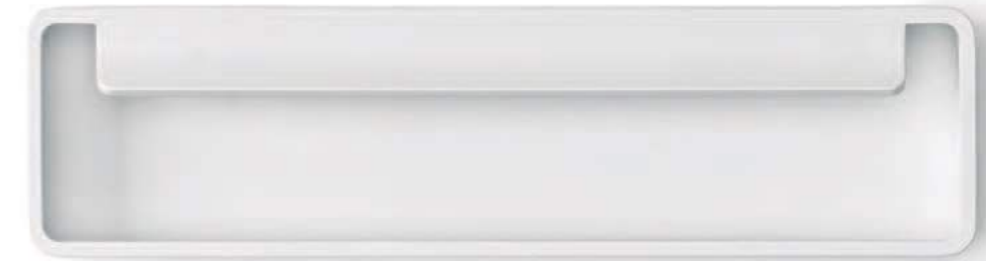

Finishes
Acabados

Brushed nickel
Níquel cepillado

Brushed brass cava
Latón cava cepillado

Matt white
Blanco mate

Matt black
Negro mate

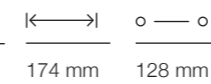

⊕
Technical info on page 323
Info técnica en pág 323



Matt white
Blanco mate
ZM1

0552

RIM

ZAMAK

Designer: Bernat Llorch

Finishes
Acabados

Brushed nickel
Níquel cepillado

Brushed brass cava
Latón cava cepillado

Matt white
Blanco mate

Matt black
Negro mate

Moss grey
Gris musgo

←→ | ○ — ○
120 mm | 96 mm



Technical info on page 322
Info técnica en pág 322



Textured black
 Negro texturizado
ZM22

0553

OTO

ZAMAK

Designer: Bernat Lluch



Finishes
Acabados

Textured black
 Negro texturizado

←→	o — o
60 mm	-
168 mm	128 mm

⊕
 Technical info on page 322
 Info técnica en pág. 322



Moss grey
Gris musgo
ZM25

0556

DIPO

ZAMAK

Designer: Bernat Lluch



Finishes
Acabados

Matt white
Blanco mate

Matt black
Negro mate

Moss grey
Gris musgo



74 mm



Technical info on page 321
Info técnica en pág. 321



Brushed dark brass
Latón cepillado oscuro
L29

0372

ONA

ALUMINIUM

Designer: Teruel & Paré



↳←	○ — ○ 1	○ — ○ 2
50 mm	32 mm	-
200 mm	128 mm	-
350 mm	256 mm	-
600 mm	544 mm	-
1100 mm	1056 mm	416 mm
1500 mm	1440 mm	480 mm

Finishes
Acabados

Stainless steel look
Inox look

Brushed dark brass
Latón cepillado oscuro

Brushed black
Negro cepillado

Brushed grey
Gris cepillado

Matt white
Blanco mate

Metallic grey
Gris metal

Metallic brown
Marrón metal



Technical info on page 343
Info técnica en pág 343



0254 / 0255

NOMA

ALUMINIUM

Designer: 2J Design



Brushed brass cava
Latón cava cepillado
L618



Finishes
Acabados

Anodized bright
Anodizado brillo

Stainless steel look
Inox look

Brushed black
Negro cepillado

Antique bronze
Bronce antiguo

Brushed brass cava
Latón cava cepillado

←→	o — o
200 mm	128 mm
350 mm	256 mm

⊕
Technical info on page 345
Info técnica en pág 345

0077

ANGLE

ALUMINIUM

Designer: Viefe Studio



Brushed dark brass
Latón cepillado oscuro
L29



Finishes
Acabados

Polished chrome
Cromo brillo

Anodized matt
Anodizado mate

Stainless steel look
Inox look

Brushed dark brass
Latón oscuro cepillado

Matt White
Bianco mate

Matt black
Negro mate

Metallic grey
Gris metal

Metallic brown
Marrón metal

←→ | o — o

- 45 mm
- 90 mm
- 100 mm
- 120 mm
- 150 mm
- 190 mm
- 200 mm
- 250 mm
- 300 mm
- 400 mm
- 500 mm
- 600 mm
- 900 mm
- 1480 mm

⊕
 Technical info on page 340
Info técnica en pág 340



Brushed gold
Oro cepillado
Z28

0495

FLOID

ZAMAK

Designer: Frank Person



Finishes
Acabados

Brushed gold
Oro cepillado

Pewter
Peltre

Antique brass
Latón antiguo

Matt black
Negro mate

← →	o — o
Ø34,8 mm	-
143,6 mm	128 mm
207,6 mm	192 mm

⊕
Technical info on page 325
Info técnica en pág 325



Matt black
Negro mate
ZM2

0496

BAU

ZAMAK

Designer: Patricia Roig



Finishes
Acabados

Brushed nickel
Níquel cepillado

Brushed gold
Oro cepillado

Matt black
Negro mate

⊘ ○ — ○
90 mm 64 mm

⊕
Technical info on page 339
Info técnica en pág 339

0127

JEY

ALUMINIUM

Designer: Viefe Studio



Brushed brass cava
Latón cava cepillado
L618

Finishes
Acabados

Stainless steel look
Inox look
Brushed brass cava
Latón cava cepillado
Matt white
Blanco mate
Matt black
Negro mate

←→|

147 mm
197 mm
247 mm
297 mm
347 mm
397 mm
447 mm
497 mm
597 mm
697 mm
797 mm
897 mm
997 mm
1197 mm
3000 mm*

* Available only in M1 and M2 finishes. Three metre profiles are delivered according to the units of the original packaging and cannot be sold separately.

Disponibile solo en los acabados M1 y M2. Las barras de tres metros se sirven según las cantidades del embalaje original y no se pueden servir por separado.

⊕
Technical info on page 326
Info técnica en pág. 326



0127 JEY

0163 JEY2 (above)

ALUMINIUM

Designer: Viefe Studio

Finishes
Acabados

Stainless steel look
Inox look

Brushed brass cava
Latón cava cepillado

Matt white
Blanco mate

Matt black
Negro mate

←→|

147 mm
197 mm
247 mm
297 mm
347 mm
397 mm
447 mm
497 mm
597 mm
697 mm
797 mm
897 mm
997 mm
1197 mm
3000 mm*

* Available only in M1 and M2 finishes. Three metre profiles are delivered according to the units of the original packaging and cannot be sold separately.

Disponibile solo en los acabados M1 y M2. Las barras de tres metros se sirven según las cantidades del embalaje original y no se pueden servir por separado.

Brushed brass cava
Latón cava cepillado
L618



Technical info on page 326
Info técnica en pág 326

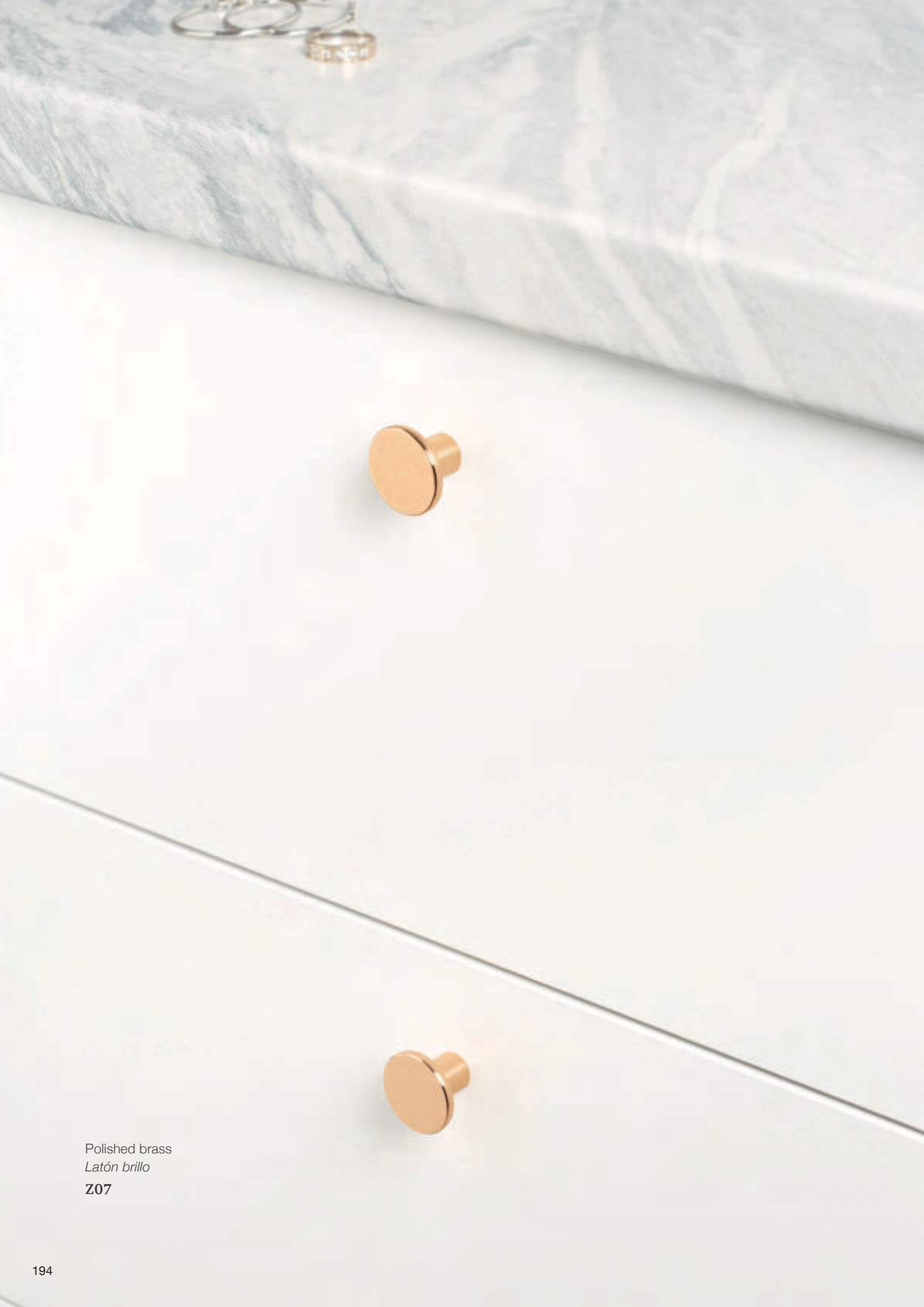

Polished brass
Latón brillo
Z07

0168

COMO

ZAMAK

Designer: Viefe Studio

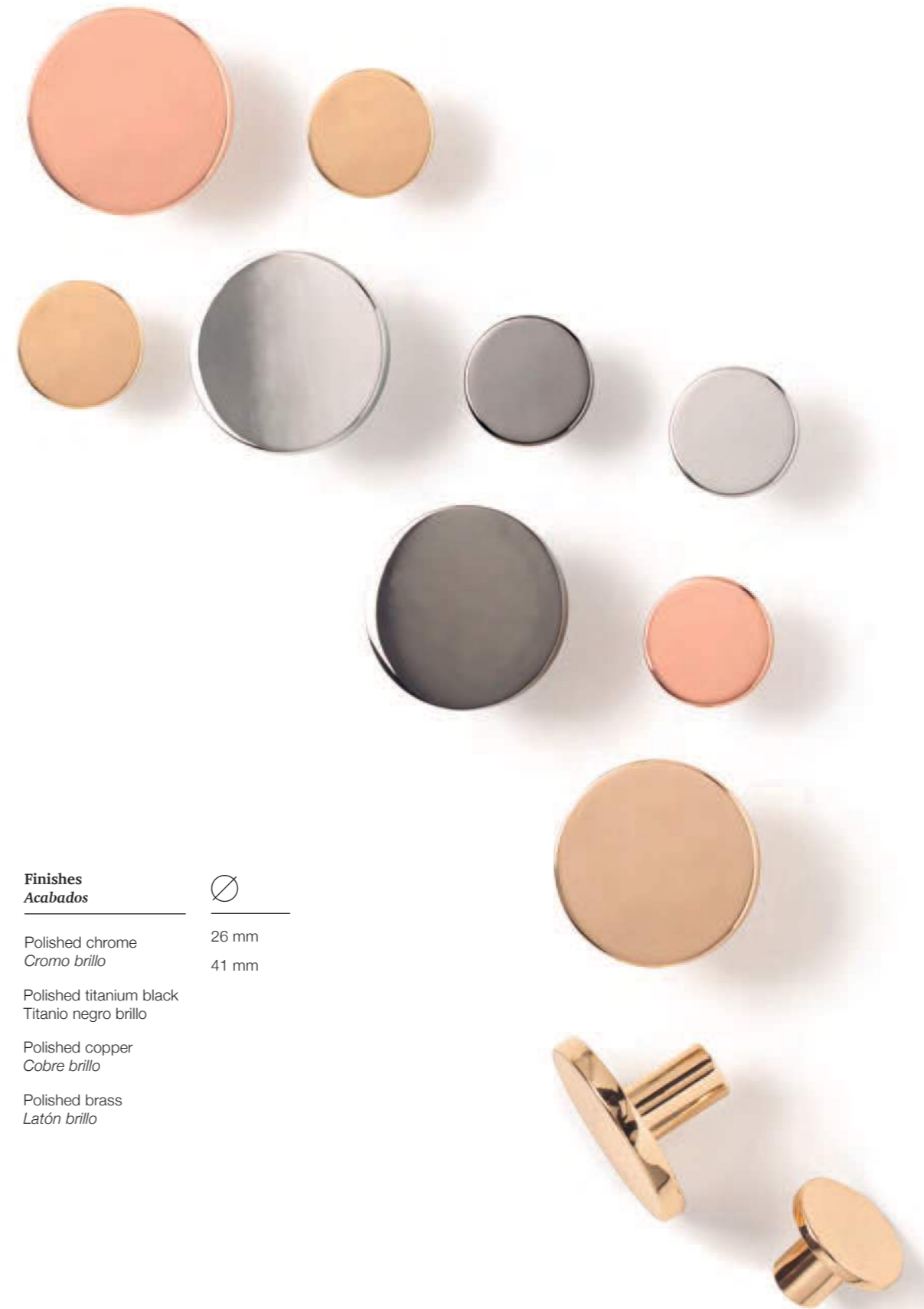

Finishes
Acabados

Polished chrome
Cromo brillo

Polished titanium black
Titanio negro brillo

Polished copper
Cobre brillo

Polished brass
Latón brillo



26 mm
 41 mm



Technical info on page 327
Info técnica en pág. 327



Brushed copper
Cobre cepillado
Z26

0168

COMO

ZAMAK

Designer: Viefe Studio

Finishes
Acabados

Matt chrome
Cromo mate

Brushed nickel
Níquel cepillado

Brushed copper
Cobre cepillado

Brushed gold
Oro cepillado

Matt black
Negro mate

Matt white
Blanco mate



26 mm

41 mm



Technical info on page 327
Info técnica en pág 327



Brushed grey
Gris cepillado
L31

0497

DIABOLO

ALUMINIUM

Designer: Frank Person



Finishes *Acabados*

Stainless steel look
Inox look

Brushed brass
Latón cepillado

Brushed black
Negro cepillado

Brushed grey
Gris cepillado



13,5 mm



Technical info on page 327
Info técnica en pág 327



Brushed brass
Latón cepillado
L291

0499

ROUND

ALUMINIUM

Designer: Balutto Associati



Finishes
Acabados

Stainless steel look
Inox look

Brushed brass
Latón cepillado

Brushed black
Negro cepillado



25 mm



Technical info on page 327
Info técnica en pág 327



Brushed dark brass
Latón oscuro cepillado
L29

0518

WAY

ALUMINIUM

Designer: Viefe Studio



Finishes
Acabados

Anodized matt
Anodizado mate

Stainless steel look
Inox look

Brushed dark brass
Latón oscuro cepillado

Matt White
Blanco mate

Matt black
Negro mate

←→	○ — ○ 1	○ — ○ 1/2	○ — ○ 2
50 mm	32 mm	-	-
100 mm	64 mm	-	-
200 mm	128 mm	-	-
400 mm	320 mm	-	-
800 mm	736 mm	368 mm	-
1100 mm	1056 mm	-	352 mm

⊕
 Technical info on page 328
Info técnica en pág 328



Brushed brass cava
Latón cava cepillado
L618

0511

RAIL

ALUMINIUM

Designer: Teruel & Paré

Finishes

Acabados

Stainless steel look
Inox look

Brushed black
Negro cepillado

Brushed brass cava
Latón cava cepillado

←→ | o — o 1 o — o 2

180 mm	160 mm	-
280 mm	192 mm	-
600 mm	576 mm	192 mm
* 1150 mm	1120 mm	192 mm

* Off-center / *Descentrado*



Technical info on page 329
Info técnica en pág 329



Brushed grey
Gris cepillado
Z31

0056

U

ZAMAK

Designer: Viefte Studio



Finishes Acabados	↳ ← →	o — o
Polished chrome <i>Cromo brillo</i>	136,5 mm	128 mm
Matt chrome <i>Cromo mate</i>	168,5 mm	160 mm
Brushed nickel <i>Niquel cepillado</i>	200,5 mm	192 mm
Matt black <i>Negro mate</i>	328,5 mm	320 mm
Brushed copper <i>Cobre cepillado</i>	500,5 mm	492 mm
Brushed brass <i>Latón cepillado</i>		
Matt white <i>Blanco mate</i>		
Brushed grey <i>Gris cepillado</i>		

⊕
Technical info on page 329
Info técnica en pág 329



Matt black
Negro mate
ZM2



0241

ROMA

ZAMAK

Designer: 2J Design

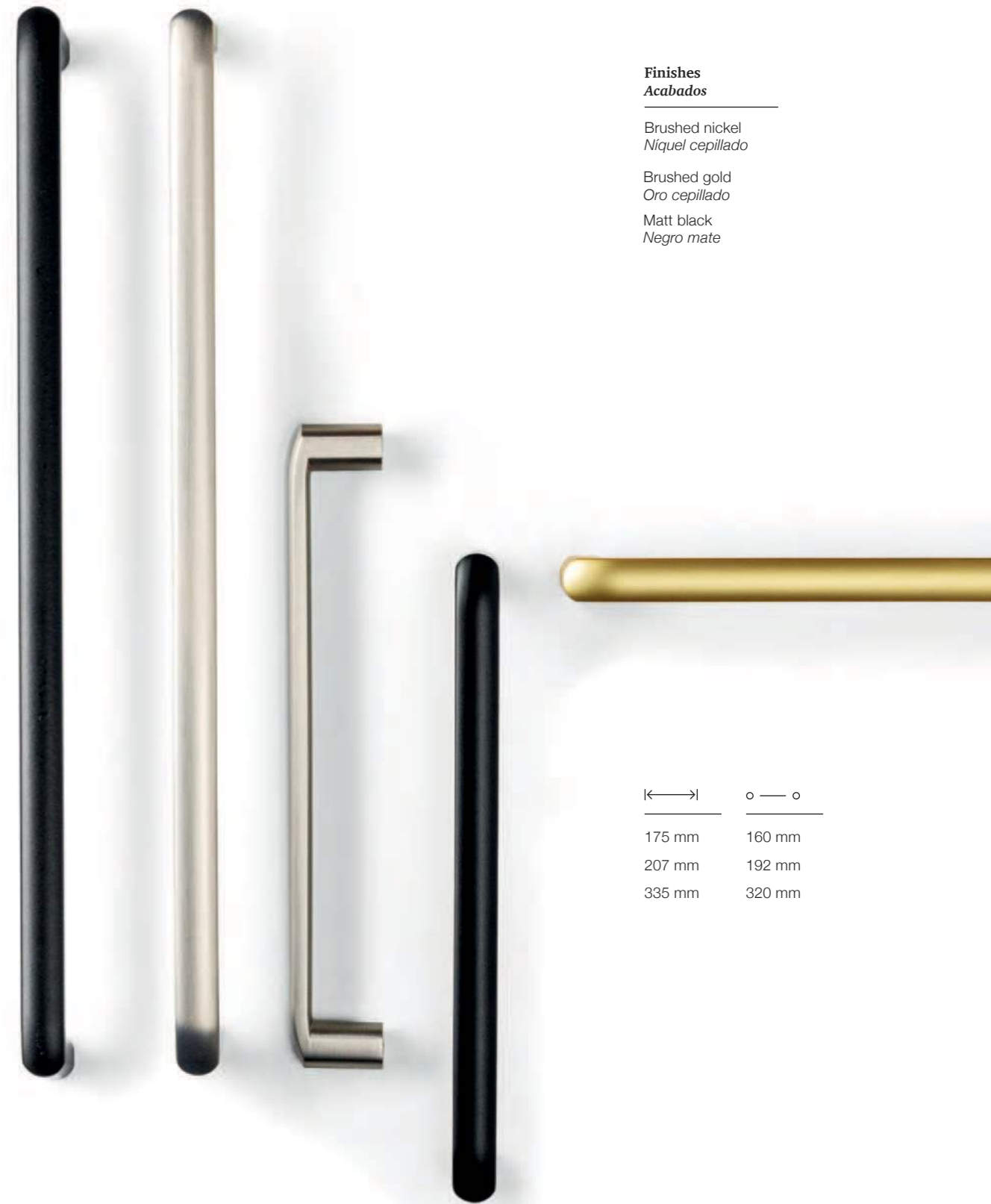

Finishes
Acabados

Brushed nickel
Níquel cepillado

Brushed gold
Oro cepillado

Matt black
Negro mate

←→	o — o
175 mm	160 mm
207 mm	192 mm
335 mm	320 mm

⊕
Technical info on page 330
Info técnica en pág 330



Matt black + Matt white lacquered
Negro mate + Lacado blanco mate
NM2M1

0489

BOL

ZAMAK / WOOD

Designer: Balutto Associati



Finishes
Acabados

Matt black + Sapelly
Negro mate + Sapelly

Matt black + Beech
Negro mate + Haya

Matt black + Matt white lacquered
Negro mate + Lacado blanco mate



45 mm



Technical info on page 328
Info técnica en pág 328



Polished chrome + Black
Cromo brillo + Negro
P9901



Brushed gold + Beige
Oro cepillado + Beige
P2628

0507

OBLONG

LEATHER / ZAMAK

Designer: Frank Person

Finishes
Acabados

Polished chrome + Beige / Brown / Black
Cromo brillo + Beige / Marrón / Negro

Brushed gold + Beige / Brown / Black
Oro cepillado + Beige / Marrón / Negro

Brushed grey + Beige / Brown / Black
Gris cepillado + Beige / Marrón / Negro

Matt white + Beige
Blanco mate + Beige

Matt black + Beige / Brown / Black
Negro mate + Beige / Marrón / Negro

$\overleftarrow{\text{K}} \rightarrow \text{I}$ <hr/> 70 mm 197 mm	$\circ \text{---} \circ$ <hr/> - 160 mm
--	---



⊕
 Technical info on page 330
Info técnica en pág 330



Polished chrome + Beige
 Cromo brillo + Beige
P2601

0404

FLEXA

LEATHER / ZAMAK

Designer: Balutto Associati



Finishes
Acabados

Polished chrome + Beige / Brown / Black
 Cromo brillo + Beige / Marrón / Negro

Pewter + Beige / Brown / Black
 Peltre + Beige / Marrón / Negro

Matt black + Beige / Brown / Black
 Negro mate + Beige / Marrón / Negro

Brushed brass + Beige / Brown / Black
 Latón cepillado + Beige / Marrón / Negro

←→	o — o
70 mm	-
150 mm	128 mm
182 mm	160 mm

⊕
 Technical info on page 350
 Info técnica en pág 350



Brushed gold
Oro cepillado
Z28

0494

LAND

ZAMAK

Designer: Héctor Diego



**Finishes
Acabados**

Brushed gold
Oro cepillado

Pewter
Peltre

Antique brass
Latón antiguo

Matt black
Negro mate

←→ | o — o

40 (Ø) mm -

98 mm 64 mm



Technical info on page 331
Info técnica en pág 331



Pewter
Peltre
Z610

0516

PENDANT

ZAMAK

Designer: Frank Person



Finishes Acabados	←→	o — o
Pewter Peltre	39,3 mm	-
Antique brass Latón antiguo	138,4 mm	128 mm
Matt black Negro mate		

⊕
Technical info on page 333
Info técnica en pág 333



Brushed brass
Latón cepillado
L291

0486

GRAF BIG

ALUMINIUM

Designer: Viefe Studio



Finishes
Acabados

Stainless steel look
Inox look

Brushed brass
Latón cepillado

Brushed black
Negro cepillado

←→	○ — ○ 1	○ — ○ 2
(Ø) 38 mm	-	-
(Ø) 50 mm	-	-
224 mm	192 mm	-
352 mm	320 mm	-
1200 mm	1168 mm	584 mm

⊕
 Technical info on page 334
 Info técnica en pág 334



0430

GRAF MINI

ALUMINIUM

Designer: Viefe Studio

Finishes

Acabados

Stainless steel look
Inox look

Brushed brass
Latón cepillado

Brushed black
Negro cepillado

←→

○ — ○ 1

○ — ○ 2

10 mm

-

-

60 mm

-

-

Includes non-twisting tip / *Incluye punta anti-giro*

182 mm

160 mm

-

278 mm

256 mm

-

1200 mm

1178 mm

589 mm



Brushed brass
Latón cepillado
L291



Technical info on page 334
Info técnica en pág 334

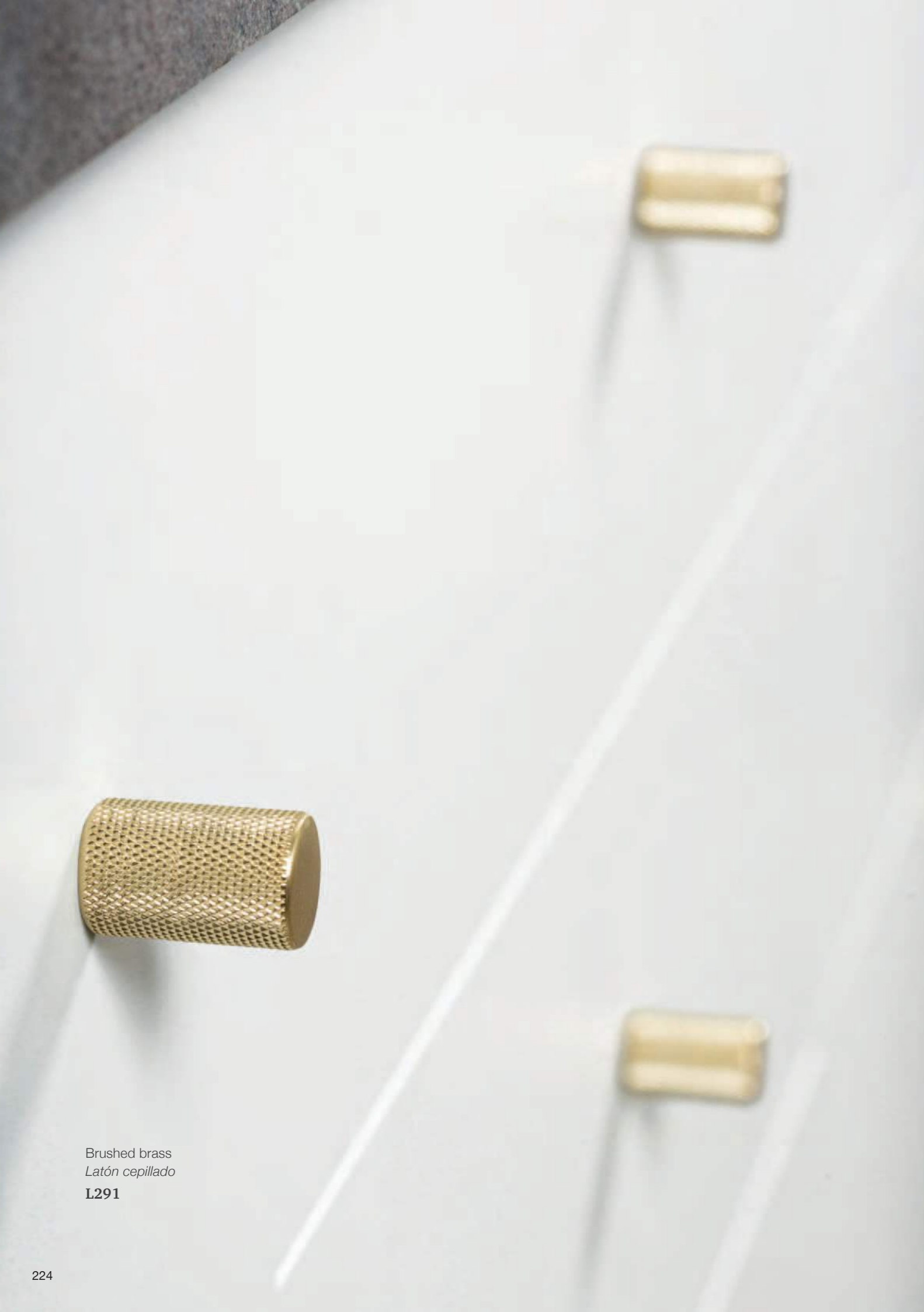

Brushed brass
Latón cepillado
L291

0109

GRAF

ALUMINIUM

Designer: Viefe Studio



Finishes
Acabados

- Polished chrome
Cromo brillo
- Anodized matt
Anodizado mate
- Stainless steel look
Inox look
- Brushed brass
Latón cepillado
- Matt black
Negro mate



17,5 mm



Technical info on page 335
Info técnica en pág 335



Brushed gold
Oro cepillado
Z28

0459

LINES

ZAMAK

Designer: Teruel & Paré

Finishes Acabados

Brushed níquel
Níquel cepillado

Brushed gold
Oro cepillado

Brushed mole grey
Gris topo cepillado

Matt black
Negro mate

← →	o — o
170 mm	160 mm
330 mm	320 mm



⊕
Technical info on page 332
Info técnica en pág 332



Brushed gold
Oro cepillado
Z28

0446

ESTE

ZAMAK

Designer: Balutto Associati

Finishes
Acabados

Polished chrome
Cromo brillo

Matt chrome
Cromo mate



Brushed nickel
Niquel cepillado

Brushed copper
Cobre cepillado

Brushed gold
Oro cepillado

Graphite grey
Gris grafito

Matt black
Negro mate



 172 mm 160 mm

 Technical info on page 331
Info técnica en pág 331



0447

BELLA

ZAMAK

Designer: Balutto Associati

Finishes
Acabados

Brushed copper
Cobre cepillado

Brushed gold
Oro cepillado

Graphite grey
Gris grafito

Matt black
Negro mate

←→ | o — o
176 mm 160 mm

⊕
Technical info on page 335
Info técnica en pág 335

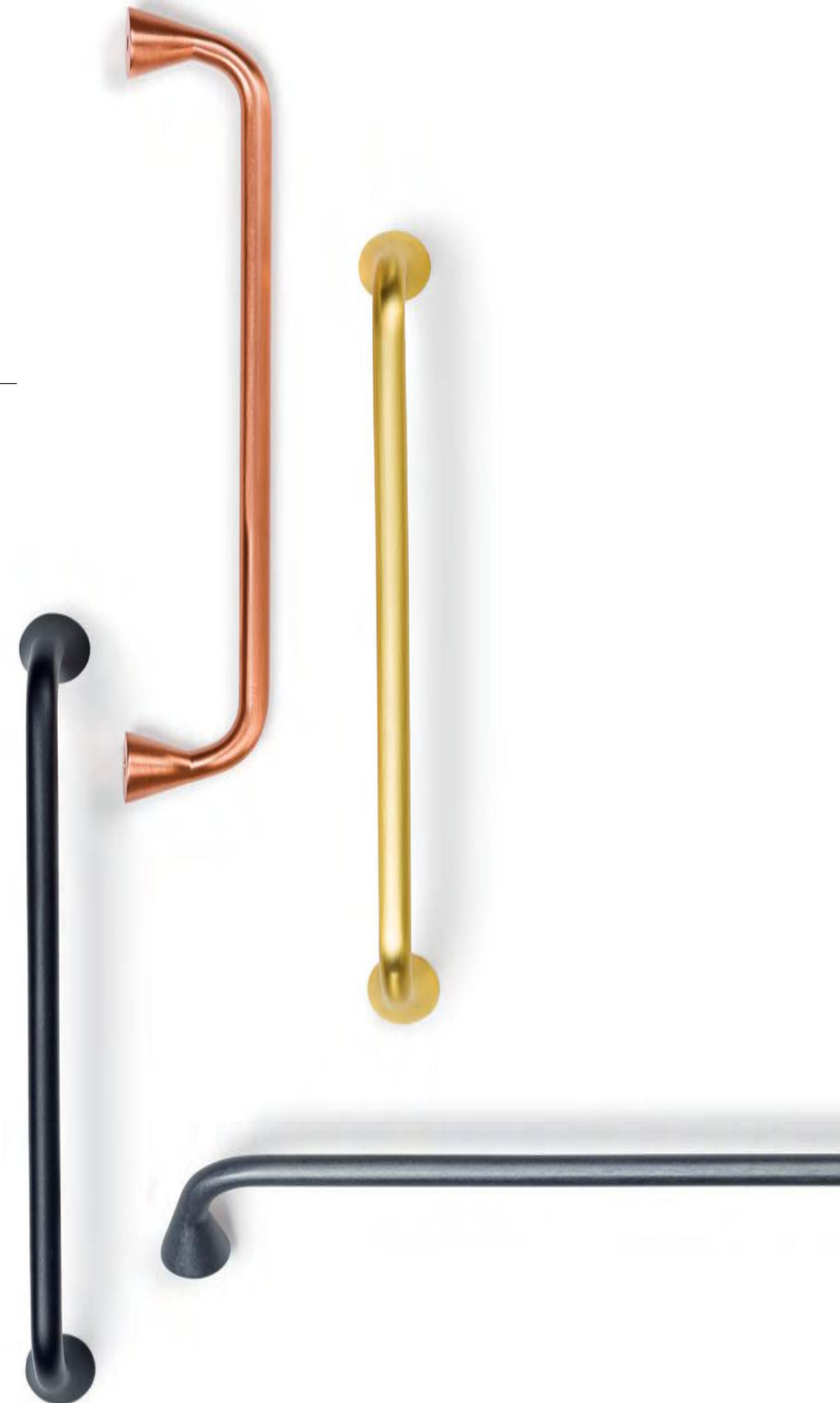

Matt black
Negro mate
ZM2



Metallic brown
Marrón metal
LM41

0449

HEXXA

ALUMINIUM + ZAMAK

Designer: Alexis Vivet

Finishes
Acabados

Matt white
Blanco mate

Matt black
Negro mate

Metallic grey
Gris metal

Metallic brown
Marrón metal

←→

200 mm

350 mm

1100 mm

3000 mm *

*

Three metre profiles are delivered according to the units of the original packaging and cannot be sold separately.

Las barras de tres metros se sirven según las cantidades del embalaje original y no se pueden servir por separado.



Technical info on page 336
Info técnica en pág 336



Brushed gold
Oro cepillado
Z28

0094

HIDE

ZAMAK

Designer: Viefe Studio



Finishes
Acabados

	←→	o — o
Polished chrome <i>Cromo brillo</i>	90 mm	64 mm
Brushed nickel <i>Niquel cepillado</i>	180 mm	128 mm
Brushed gold <i>Oro cepillado</i>	200 mm	128 mm
Matt white <i>Blanco mate</i>		
Matt black <i>Negro mate</i>		
Chrome look <i>Cromo look</i>		

⊕
Technical info on page 333
Info técnica en pág. 333



Matt black
Negro mate
ZM2

0119

WAVE

ZAMAK

Designer: Viefe Studio

Finishes
Acabados

Brushed nickel
Níquel cepillado

Matt black
Negro mate

←→	o — o
45 mm	32 mm
173 mm	160 mm



⊕
Technical info on page 336
Info técnica en pág 336



Matt black
Negro mate
ZM2

0105

(combinable with 0094)

NEST

ZAMAK

Designer: Viefe Studio



Finishes
Acabados

Brushed nickel
Níquel cepillado

Matt black
Negro mate

←→ | ○ — ○
212,5 mm 202,5 mm



Technical info on page 337
Info técnica en pág 337

0235

CLOS

ZAMAK

Designer: Viefe Studio



Matt white
Blanco mate
ZM1



Finishes
Acabados

Matt white
Blanco mate

Matt black
Negro mate

Polished chrome
Cromo brillo

Brushed nickel
Níquel cepillado

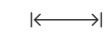

160 mm

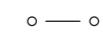

128 mm



Technical info on page 337
Info técnica en pág 337

0073

TAP

ZAMAK

Designer: Viefe Studio



Finishes
Acabados

Chrome look
Cromo look

Matt black
Negro mate

∅ 1

35,5 mm

55,3 mm

∅ 2

40 mm

60 mm



Technical info on page 338
Info técnica en pág 338

Matt black
Negro mate
ZM2



Brushed dark brass
Latón oscuro cepillado
L29

0301

SENSE MINI

ALUMINIUM

Designer: Viefte Studio



Finishes
Acabados

Polished chrome
Cromo brillo

Matt black
Negro mate

Stainless steel look
Inox look

Brushed dark brass
Latón oscuro cepillado

←→	o — o
103 mm	96 mm
167 mm	160 mm
263 mm	256 mm

⊕
 Technical info on page 338
Info técnica en pág 338



Brushed black
Negro cepillado
L30



0195

SENSE

ALUMINIUM

Designer: Viefe Studio



Finishes
Acabados

Polished chrome
Cromo brillo

Stainless steel look
Inox look

Brushed black
Negro cepillado

←→	○ — ○
135 mm	128 mm
199 mm	192 mm
327 mm	320 mm
487 mm	480 mm

⊕
Technical info on page 338
Info técnica en pág. 338



Graphite grey
Gris grafito
Z617

0451

FELTRE

ZAMAK

Designer: Balutto Associati



Finishes
Acabados

Brushed nickel
Níquel cepillado

Graphite grey
Gris grafito

Matt black
Negro mate

←→ | o — o
218 mm 192 mm

⊕
Technical info on page 335
Info técnica en pág 335

0452

BRAVE

ALUMINIUM

Designer: Viefe Studio



Metallic brown
Marrón metal
LM41



Finishes
Acabados

Matt white
Blanco mate

Matt black
Negro mate

Metallic grey
Gris metal

Metallic brown
Marrón metal

←→	o — o 1	o — o 2
160 mm	128 mm	-
240 mm	192 mm	-
400 mm	320 mm	-
600 mm	192 mm	480 mm
1040 mm	192 mm	992 mm
1150 mm	192 mm	1120 mm



Technical info on page 341
Info técnica en pág 341

0444

PEAK

ALUMINIUM

Designer: Viefe Studio



Metallic brown
Marrón metal
LM41

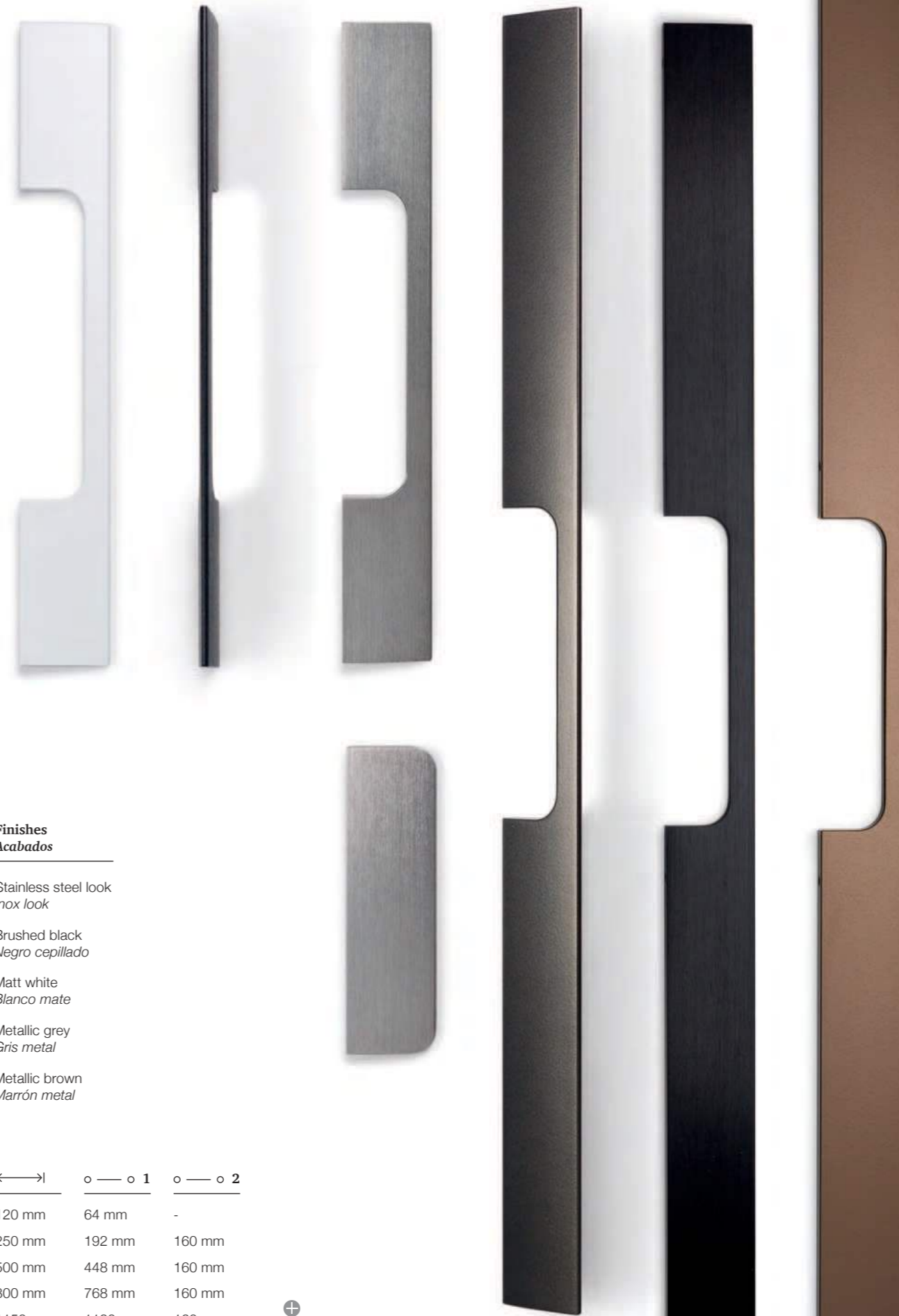

Finishes
Acabados

Stainless steel look
Inox look

Brushed black
Negro cepillado

Matt white
Blanco mate

Metallic grey
Gris metal

Metallic brown
Marrón metal

←→	o — o 1	o — o 2
120 mm	64 mm	-
250 mm	192 mm	160 mm
500 mm	448 mm	160 mm
800 mm	768 mm	160 mm
1150 mm	1120 mm	160 mm
1800 mm	1760 mm	160 mm

⊕
Technical info on page 342
info técnica en pág 342

0117

CURVE

ALUMINIUM

Designer: Viefe Studio

Brushed grey
Gris cepillado
L31

Finishes Acabados

Anodized matt
Anodizado mate

Stainless steel look
Inox look

Brushed grey
Gris cepillado

Matt white
Blanco mate

Matt black
Negro mate

←→	o — o
45 mm	32 mm
100 mm	64 mm
200 mm	128 mm
300 mm	192 mm
400 mm	320 mm
500 mm	416 mm



Technical info on page 344
Info técnica en pág 344

0139 / 0140

LINEAR

ALUMINIUM

Designer: Viefe Studio



Brushed black
Negro cepillado
L30

Finishes
Acabados

Stainless steel look
Inox look

Brushed black
Negro cepillado

←→

147 mm

197 mm

247 mm

297 mm

347 mm

397 mm

447 mm

497 mm

597 mm

697 mm

797 mm

897 mm

997 mm

1197 mm



Technical info on page 344
Info técnica en pág 344

0434

VECTOR

ALUMINIUM

Designer: Viefe Studio



Brushed black
Negro cepillado
L30



Finishes *Acabados*

Stainless steel look
Inox look

Brushed black
Negro cepillado

Brushed grey
Gris cepillado

←→

- 147 mm
- 197 mm
- 247 mm
- 297 mm
- 347 mm
- 397 mm
- 447 mm
- 497 mm
- 597 mm
- 697 mm
- 797 mm
- 897 mm
- 997 mm
- 1197 mm

⊕
Technical info on page 345
Info técnica en pág 345



Matt black
Negro mate
LM2

0343

GRADA

ALUMINIUM

Designer: Viefe Studio

**Finishes
Acabados**

|←→|

Anodized matt <i>Anodizado mate</i>	147 mm 197 mm
Stainless steel look <i>Inox look</i>	247 mm 297 mm
Matt white <i>Blanco mate</i>	347 mm 397 mm
Matt black <i>Negro mate</i>	447 mm 497 mm
Anodized bright <i>Anodizado brillo</i>	597 mm 697 mm 797 mm 897 mm 997 mm 1197 mm 3000 mm *

*
Three metre profiles are delivered according to the units of the original packaging and cannot be sold separately.

Las barras de tres metros se sirven según las cantidades del embalaje original y no se pueden servir por separado.



Technical info on page 346
Info técnica en pág 346

0380

STEEP

ALUMINIUM

Designer: Viefe Studio

Finishes Acabados

Anodized bright
Anodizado brillo

Stainless steel look
Inox look

Matt black
Negro mate



3000 mm

Three metre profiles are delivered according to the units of the original packaging and cannot be sold separately.

Las barras de tres metros se sirven según las cantidades del embalaje original y no se pueden servir por separado.



Technical info on page 346
Info técnica en pág 346

Matt black
Negro mate
LM2

0250 / 0251

FORMA

ALUMINIUM

Designer: 2J Design



Stainless steel look
Inox look
L24

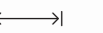

147 mm

197 mm

247 mm

297 mm

347 mm

397 mm

447 mm

497 mm

597 mm

697 mm

797 mm

897 mm

997 mm

1197 mm

Finishes Acabados

Stainless steel look
Inox look



Technical info on page 325
Info técnica en pág 325

Brushed nickel
Níquel cepillado
Z23

0053

DINO

ZAMAK

Designer: Viefte Studio



Finishes
Acabados

Polished chrome
Cromo brillo

Brushed nickel
Níquel cepillado

Matt white
Blanco mate

Matt black
Negro mate

←→	o — o 1	o — o 2
156 mm	96 mm	128 mm
221 mm	160 mm	192 mm
349 mm	288 mm	320 mm

⊕
Technical info on page 343
Info técnica en pág 343



Brushed brass
 Latón cepillado
Z27

0373

NICK

ZAMAK

Designer: Alexis Vivet



Finishes
Acabados

Polished chrome
 Cromo brillo

Brushed nickel
 Níquel cepillado

Brushed copper
 Cobre cepillado

Brushed brass
 Latón cepillado

←→	o — o
50 mm	32 mm
178 mm	160 mm

⊕
 Technical info on page 339
 Info técnica en pág 339

0322

CUTT

ALUMINIUM

Designer: Alexis Vivet



Matt black anodized
Negro mate anodizado
L09

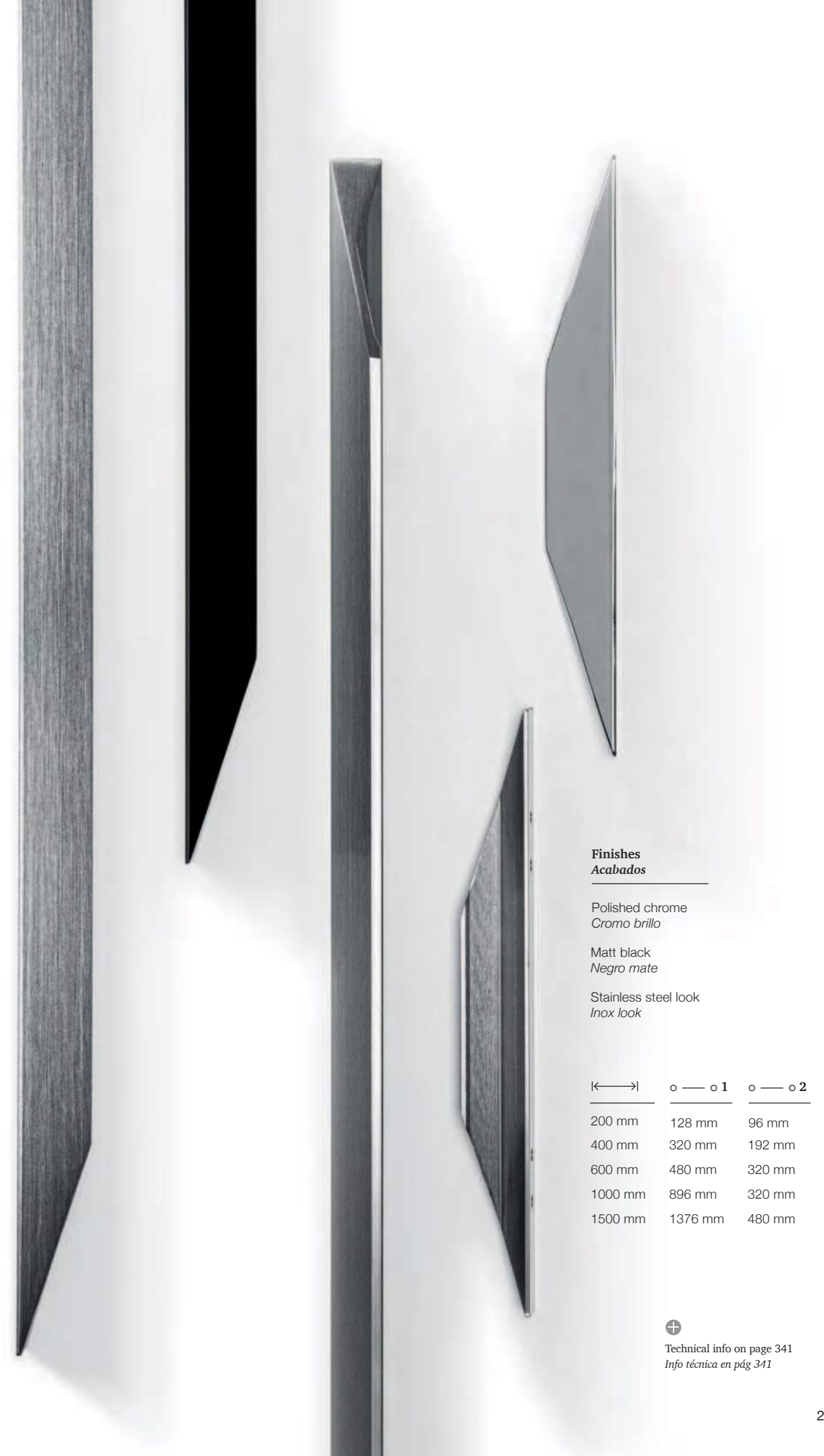

Finishes
Acabados

Polished chrome
Cromo brillo

Matt black
Negro mate

Stainless steel look
Inox look

↳→	○ — ○ 1	○ — ○ 2
200 mm	128 mm	96 mm
400 mm	320 mm	192 mm
600 mm	480 mm	320 mm
1000 mm	896 mm	320 mm
1500 mm	1376 mm	480 mm



Technical info on page 341
Info técnica en pág 341



Pewter
Peltre
Z610

0410

BUTTON

ZAMAK

Designer: Alexis Vivet



Finishes
Acabados

Pewter
Peltre

Antique Brass
Latón antiguo

Matt black
Negro mate

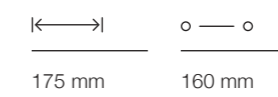

⊕
Technical info on page 347
Info técnica en pág 347



Matt black
Negro mate
ZM2

0393

DUKE

ZAMAK

Designer: Viefe Studio



Finishes
Acabados

Antique copper
Cobre antiguo

Antique silver
Plata antigua

Matt black
Negro mate

Matt white
Blanco mate

Pewter
Peltre

Antique Brass
Latón antiguo

Polished chrome
Cromo brillo

Brushed nickel
Níquel cepillado

Brushed brass
Latón cepillado

Brushed copper
Cobre cepillado



31,4 mm



Technical info on page 347
Info técnica en pág 347

0226

REDO

ZAMAK

Designer: 2J Design



Antique brass
Latón antiguo
Z614

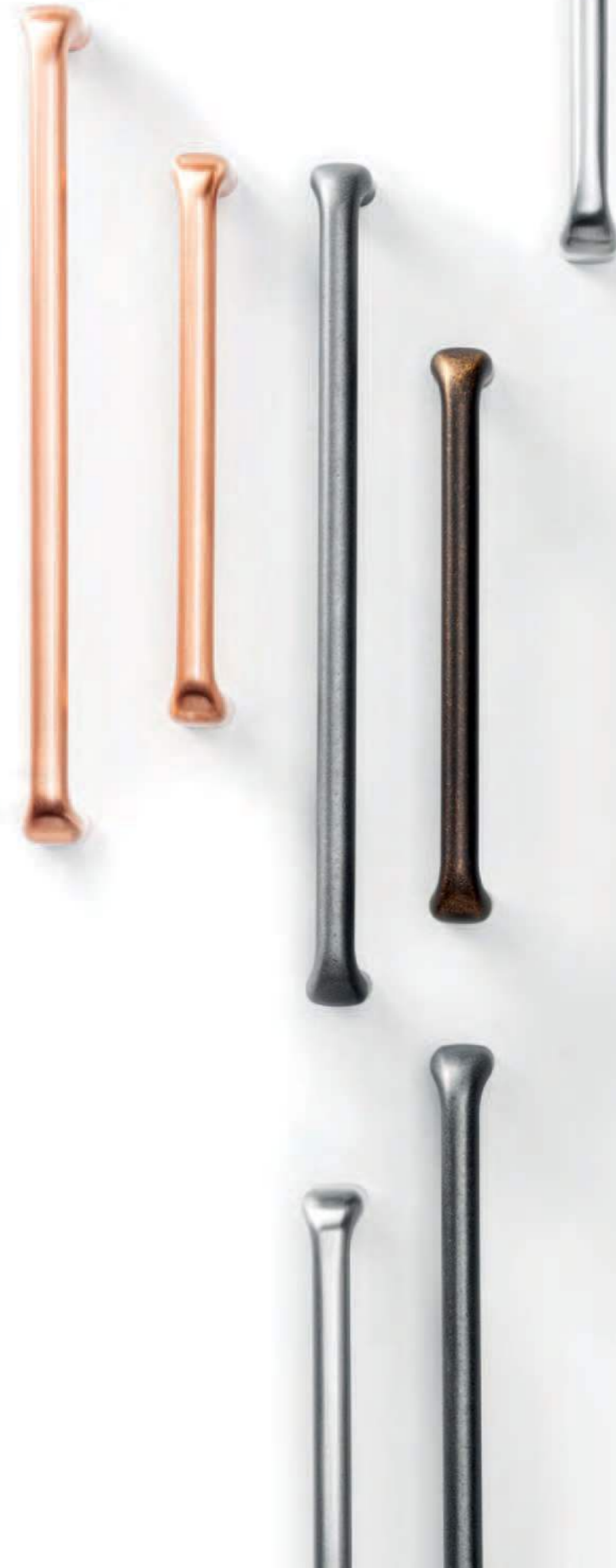

Finishes
Acabados

Antique Brass
Latón antiguo

Brushed nickel
Níquel cepillado

Brushed copper
Cobre cepillado

Pewter
Peltre

←→

o — o

137 mm

128 mm

201 mm

192 mm



Technical info on page 348
Info técnica en pag 348



Antique brass
Latón antiguo
Z614

0405

RAVIOLO

ZAMAK

Designer: Balutto Associati



Finishes
Acabados

Pewter
Peltre

Antique Brass
Latón antiguo

← →

Ø 29 mm

172 mm

○ — ○

-

96 mm



Technical info on page 348
Info técnica en pág 348

0366

CUBIC

ZAMAK

Designer: Viefe Studio

Finishes
Acabados

Matt white
Blanco mate

Matt black
Negro mate



160 mm



Technical info on page 337
Info técnica en pág 337

0390

PETRA

ZAMAK

Designer: Viefe Studio



Antique cooper
Cobre antiguo
Z66

0064

KOMBI

STAINLESS STEEL

Designer: Viefe Studio

Finishes
Acabados

Brushed stainless steel
Inox cepillado



182 mm

214 mm

314 mm

364 mm

414 mm

514 mm

814 mm

1114 mm



160 mm

192 mm

292 mm

342 mm

392 mm

492 mm

792 mm

1092 mm



Technical info on page 353
Info técnica en pág 353

Finishes
Acabados

Antique copper
Cobre antiguo

Antique silver
Plata antigua

Matt black
Negro mate



97 mm



64 mm



Technical info on page 349
Info técnica en pág 349

0392

ORION

ZAMAK

Designer: Viefe Studio



Finishes
Acabados

Antique copper
Cobre antiguo

Antique silver
Plata antigua



136 mm



128 mm



Technical info on page 349
Info técnica en pág 349

Antique cooper
Cobre antiguo
Z66



0391

AURA

ZAMAK

Designer: Viefe Studio



Finishes
Acabados

Antique copper
Cobre antiguo

Antique silver
Plata antigua



87 mm



64 mm



Technical info on page 349
Info técnica en pág 349

Antique cooper
Cobre antiguo
Z66



0239

ARA W

ALUMINIUM + WOOD

Designer: 2J Design



Stainless steel look + Walnut
Inox look + Nogal
N2417



Finishes
Acabados

- Stainless steel look + Oak
- Inox look + Roble*
- Stainless steel look + Walnut
- Inox look + Nogal*

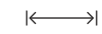

220 mm
 284 mm

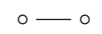

160 mm
 224 mm



Technical info on page 350
Info técnica en pág 350



Walnut
Nogal
W19

0340

BARCCO

WOOD

Designer: Alexis Vivet



Finishes
Acabados

Ash
Fresno

Walnut
Nogal

Beech raw
Haya crudo

←→	o — o 1	o — o 2
200 mm	160 mm	-
400 mm	320 mm	-
600 mm	320 mm	480 mm

⊕
Technical info on page 351
Info técnica en pág 351

0165

CALIN

WOOD

Designer: Viefe Studio



Black brushed
Negro cepillado
W09



Finishes Acabados

Raw brushed
Crudo cepillado

White brushed
Blanco cepillado

Brown brushed
Marrón cepillado

Black brushed
Negro cepillado

 240 mm
  160 mm

 Technical info on page 351
 Info técnica en pág. 351



0166

ECHO

WOOD

Designer: Viefe Studio



Finishes Acabados

Raw brushed
Crudo cepillado

White brushed
Blanco cepillado

Brown brushed
Marrón cepillado

Black brushed
Negro cepillado



60 mm



Technical info on page 351
 Info técnica en pág. 351

0219

ARROW

ZAMAK

Designer: 2J Design

Finishes Acabados

Brushed nickel
Níquel cepillado



223 mm

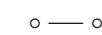

192 mm



Technical info on page 347
 Info técnica en pág. 347

0243 ST

LOW ST

ZAMAK

Designer: Viefe Studio

**Finishes
Acabados**

Brushed nickel
Níquel cepillado

←→	○ — ○
78 mm	64 mm
206 mm	192 mm



Technical info on page 352
Info técnica en pág 352

0281

FLAT

ZAMAK

Designer: Oriol Barri

**Finishes
Acabados**

Brushed nickel
Níquel cepillado

←→	○ — ○
174,8 mm	160 mm



Technical info on page 352
Info técnica en pág 352

0376

BOXX

ZAMAK

Designer: Alexis Vivet



Polished chrome
Cromo brillo
Z01



**Finishes
Acabados**

Polished chrome
Cromo brillo

Matt chrome
Cromo mate

Brushed nickel
Níquel cepillado

Matt black
Negro mate

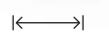

15 mm



Technical info on page 353
Info técnica en pág 353

0206

ARCH

ZAMAK

Designer: 2J Design



Finishes
Acabados
Brushed nickel
Níquel cepillado

	↳	○
	208,5 mm	192 mm
	338,5 mm	320 mm

⊕
Technical info on page 340
Info técnica en pág 340

0091

RASO

ZAMAK

Designer: Vief Studio

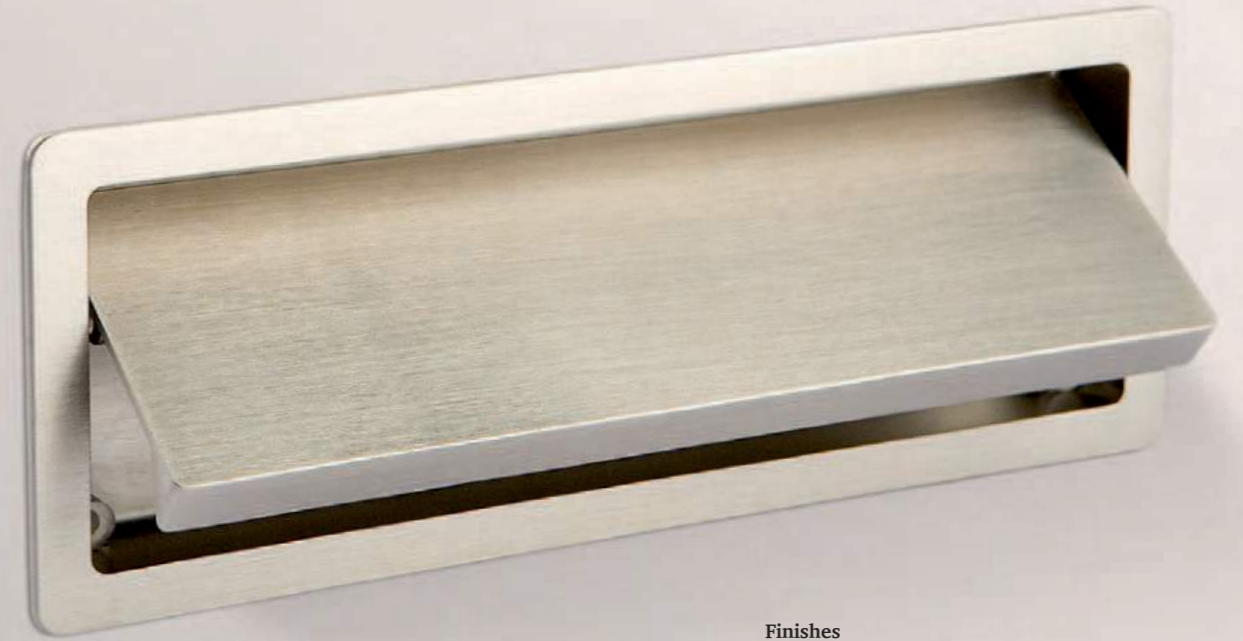

Finishes
Acabados
Brushed nickel
Níquel cepillado

	↳	○
	70 mm	32 mm
	152,5 mm	108 mm

⊕
Technical info on page 352
Info técnica en pág 352

0162

KADO

ZAMAK

Designer: Vief Studio



Finishes
Acabados
Brushed nickel
Níquel cepillado

	↳	○
	186 mm	160 mm
	346 mm	320 mm

⊕
Technical info on page 339
Info técnica en pág 339

0312

ARKO

ALUMINIUM

Designer: Vief Studio



Finishes
Acabados
Stainless steel look
Inox look

	↳	○
	186 mm	160 mm
	218 mm	192 mm
	292 mm	256 mm

⊕
Technical info on page 348
Info técnica en pág 348

6005

FONDA

ALUMINIUM

Designer: Viefe Studio



Brushed dark brass
Latón oscuro cepillado
L29



Finishes
Acabados

	↕
Polished chrome <i>Cromo brillo</i>	100 mm
Stainless steel look <i>Inox look</i>	150 mm
Brushed dark brass <i>Latón oscuro cepillado</i>	200 mm
Brushed black <i>Negro cepillado</i>	



Technical info on page 353
Info técnica en pág 353

TECHNICAL DATA

EN |

It's what you don't see where our true quality lies.

ES |

En los detalles más imperceptibles reside el valor de nuestra calidad.

CA |

En els detalls més imperceptibles hi ha el valor de la nostra qualitat.

0646 **MILANO** ZAMAK Designer: Kaschkasch **NEW!**

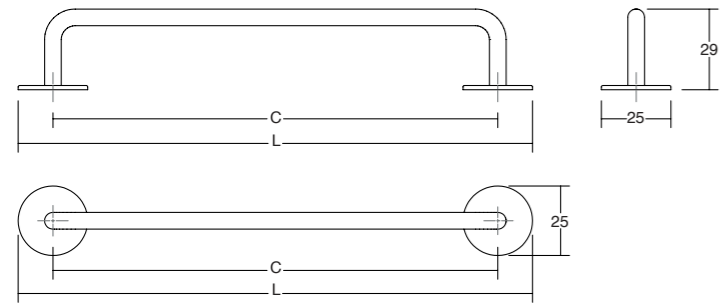

ZM1	ZM2	ZM25	ZM31	ZM72	ZM82	C	L	↓	☐
Matt white <i>Blanco mate</i>	Matt black <i>Negro mate</i>	Moss grey <i>Gris musgo</i>	Forest green <i>Verde forest</i>	Volcano red <i>Rojo volcano</i>	Midnight blue <i>Azul midnight</i>				
0646096ZM1	0646096ZM2	0646096ZM25	0646096ZM31	0646096ZM72	0646096ZM82	96	121	2	25
0646160ZM1	0646160ZM2	0646160ZM25	0646160ZM31	0646160ZM72	0646160ZM82	160	185	2	25

0699 **LUV WOOD** WOOD Designer: Kaschkasch **NEW!**

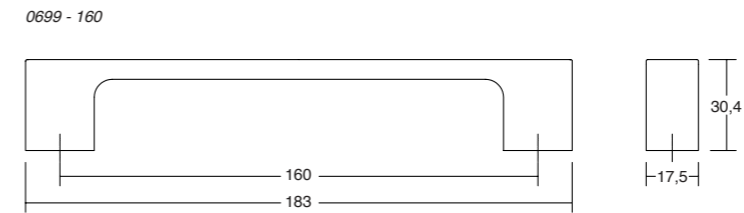
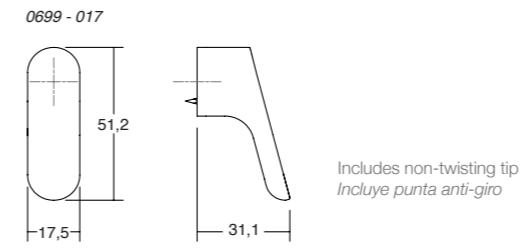

W00	W16	W17	WM2	↓	☐
Raw oak <i>Roble crudo</i>	Oak <i>Roble</i>	Walnut <i>Nogal</i>	Oak matt black lacquered <i>Roble lacado negro mate</i>		
0699017W00	0699017W16	0699017W17	0699017WM2	1	25
0699160W00	0699160W16	0699160W17	0699160WM2	2	25

0666 **SIX** ALUMINIUM Designer: Viefe Studio **NEW!**

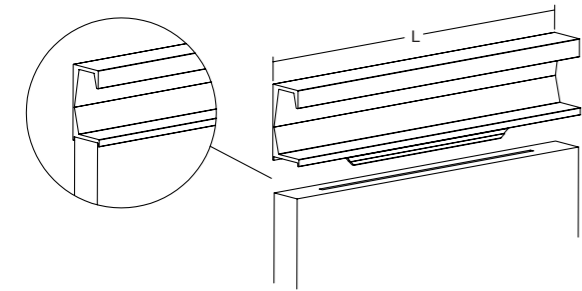

LMT1	LMT27	LMT41	L	☐
Textured matt white <i>Blanco mate texturizado</i>	Textured lava black <i>Negro lava texturizado</i>	Textured metallic brown <i>Marrón metal texturizado</i>		
0666147LMT1	0666147LMT27	0666147LMT41	147	15
0666197LMT1	0666197LMT27	0666197LMT41	197	15
0666247LMT1	0666247LMT27	0666247LMT41	247	15
0666297LMT1	0666297LMT27	0666297LMT41	297	15
0666347LMT1	0666347LMT27	0666347LMT41	347	15
0666397LMT1	0666397LMT27	0666397LMT41	397	15
0666447LMT1	0666447LMT27	0666447LMT41	447	10
0666497LMT1	0666497LMT27	0666497LMT41	497	10
0666597LMT1	0666597LMT27	0666597LMT41	597	10
0666697LMT1	0666697LMT27	0666697LMT41	697	10
0666797LMT1	0666797LMT27	0666797LMT41	797	10
0666897LMT1	0666897LMT27	0666897LMT41	897	5
0666997LMT1	0666997LMT27	0666997LMT41	997	5
06661197LMT1	06661197LMT27	06661197LMT41	1197	5
06663000LMT1	06663000LMT27	06663000LMT41	3000	5*

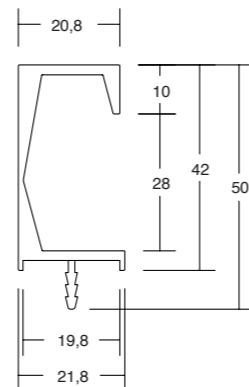

* Three metre profiles are delivered according to the units of the original packaging and cannot be sold separately.
Las barras de tres metros se sirven según las cantidades del embalaje original y no se pueden servir por separado.

0673 **BEAM** ZAMAK Designer: Johannes Lindner **NEW!**

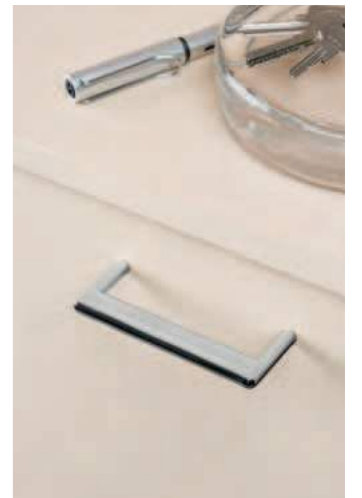
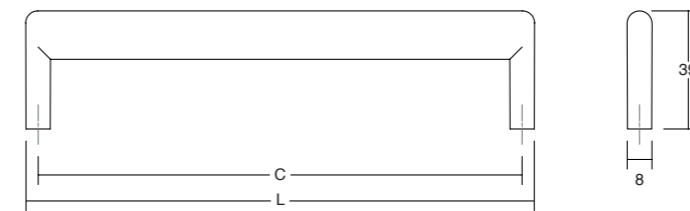

Z03	Z05	Z07	Z23	Z33	Z618	ZM2	C	L	↓	☐
Polished titanium black <i>Titanio negro brillo</i>	Polished nickel <i>Níquel brillo</i>	Polished brass <i>Latón brillo</i>	Brushed nickel <i>Níquel cepillado</i>	Titanium black <i>Negro titanio</i>	Brushed brass cava <i>Latón cava cepillado</i>	Matt black <i>Negro mate</i>				
0673096Z03	0673096Z05	0673096Z07	0673096Z23	0673096Z33	0673096Z618	0673096ZM2	96	104	2	25
0673160Z03	0673160Z05	0673160Z07	0673160Z23	0673160Z33	0673160Z618	0673160ZM2	160	168	2	25
0673320Z03	0673320Z05	0673320Z07	0673320Z23	0673320Z33	0673320Z618	0673320ZM2	320	328	2	25

0674 **PIECE** WOOD Designer: Steffensen & Würtz **NEW!**

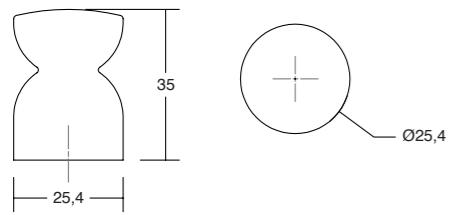

W16	W17	WM2		
Oak	Walnut	Oak matt black lacquered	↓	☐
Roble	Nogal	Roble lacado negro mate		
0674025W16	0674025W17	0674025WM2	1	25

0676 **BROOKLYN** ALUMINIUM Designer: Steffensen & Würtz **NEW!**

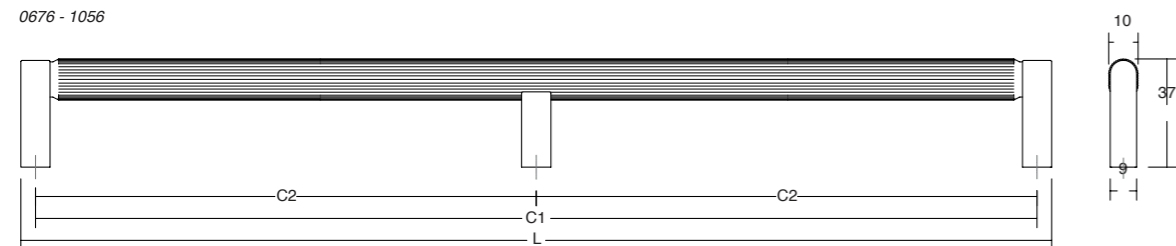
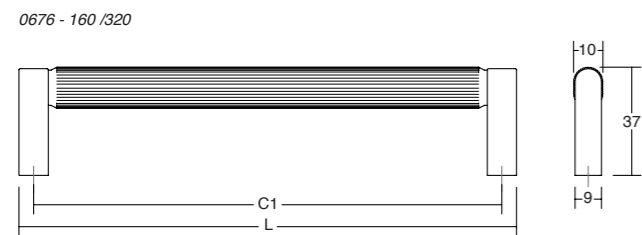
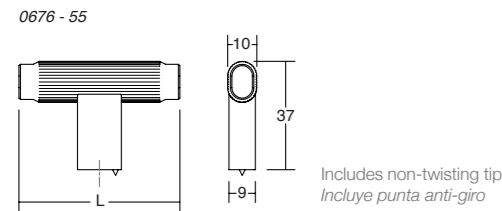

L05	L30	L33	L618	L619	C1	C2	L	↓	☐
Polished nickel	Brushed black	Titanium black	Brushed brass cava	Brushed bronze					
Niquel brillo	Negro cepillado	Negro titanio	Latón cava cepillado	Bronce cepillado					
0676055L05	0676055L30	0676055L33	0676055L618	0676055L619	-	-	55	1	25
0676160L05	0676160L30	0676160L33	0676160L618	0676160L619	160	-	170	2	25
0676320L05	0676320L30	0676320L33	0676320L618	0676320L619	320	-	330	2	25
06761056L05	06761056L30	06761056L33	06761056L618	06761056L619	1056	528	1066	3	10

0677 / 0678 / 0679 **BROOKLYN BIG** ALUMINIUM Designer: Steffensen & Würtz

Available with one side system / Disponible con sistema de una cara
Available with back to back system / Disponible con sistema de doble cara

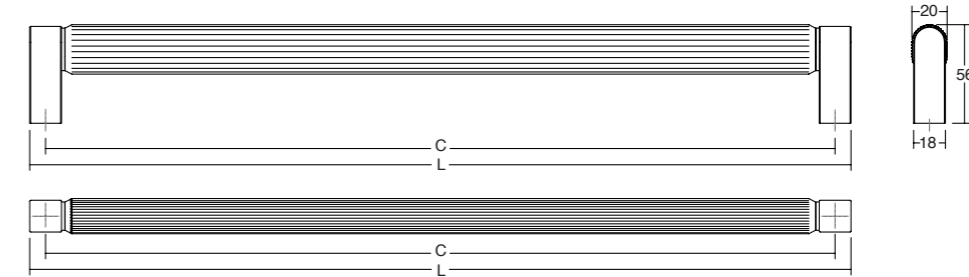

L05	L30	L33	L618	L619	C	L	↓	☐
Polished nickel	Brushed black	Titanium black	Brushed brass cava	Brushed bronze				
Niquel brillo	Negro cepillado	Negro titanio	Latón cava cepillado	Bronce cepillado				
0677448L05	0677448L30	0677448L33	0677448L618	0677448L619	448	466	2	2
06771056L05	06771056L30	06771056L33	06771056L618	06771056L619	1056	1074	2	2
0678448L05	0678448L30	0678448L33	0678448L618	0678448L619	448	466	2	2
06781056L05	06781056L30	06781056L33	06781056L618	06781056L619	1056	1074	2	2
0679448L05	0679448L30	0679448L33	0679448L618	0679448L619	448	466	2	1
06791056L05	06791056L30	06791056L33	06791056L618	06791056L619	1056	1074	2	1

0681 **HINOKI** WOOD Designer: Alexis Vivet **NEW!**

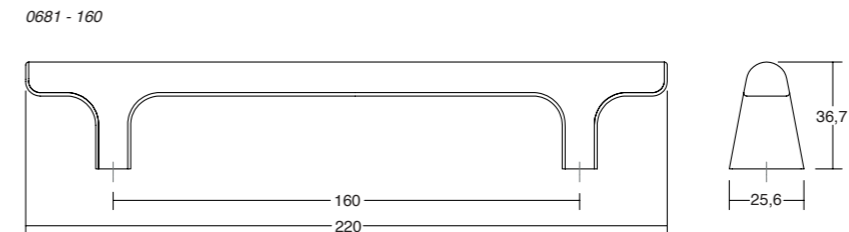
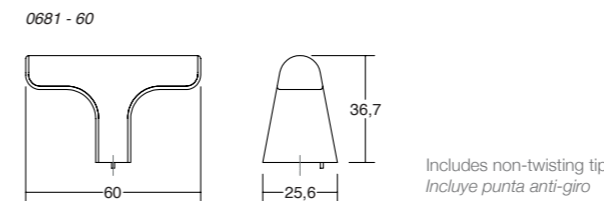

W16	W17	W00		
Oak	Walnut	Raw oak	↓	☐
Roble	Nogal	Roble crudo		
0681060W16	0681060W17	0681060W00	1	25
0681160W16	0681160W17	0681160W00	2	25

0682 **HINOKI WOOD BIG** WOOD Designer: Alexis Vivet **NEW!**



0682 - 416

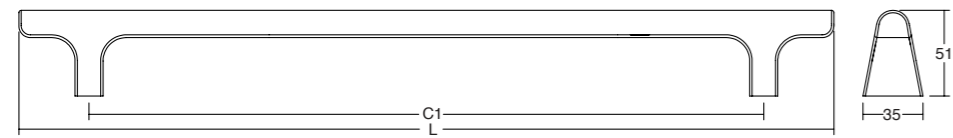

0682 - 832

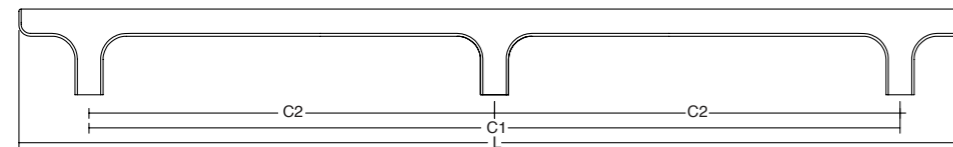

W16 Oak Roble	W17 Walnut Nogal	W00 Raw oak Roble crudo	C1	C2	L	↓	☐
0682416W16	0682416W17	0682416W00	416	-	500	2	15
0682832W16	0682832W17	0682832W00	832	416	915	3	10

0687 **HINOKI BIG** ALUMINIUM Designer: Alexis Vivet **NEW!**



0682 - 416

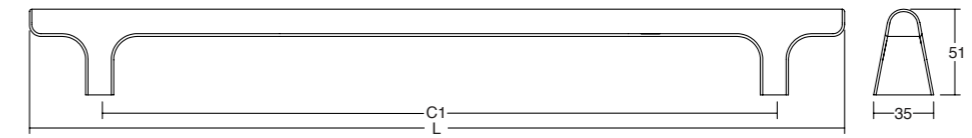

0682 - 832

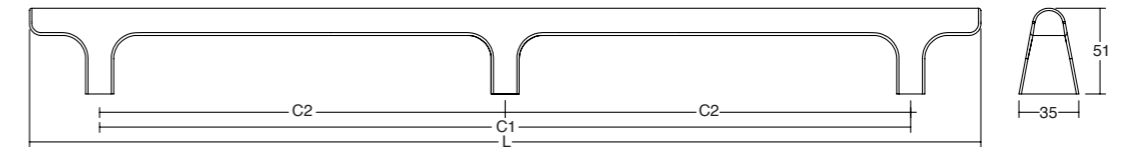

L30 Brushed black Negro cepillado	L618 Brushed brass cava Latón cava cepillado	L619 Brushed bronze Bronce cepillado	C1	C2	L	↓	☐
0687416L30	0687416L618	0687416L619	416	-	500	2	15
0687832L30	0687832L618	0687832L619	832	416	915	3	10

0686 **HINOKI** ALUMINIUM Designer: Alexis Vivet **NEW!**



0686 - 60

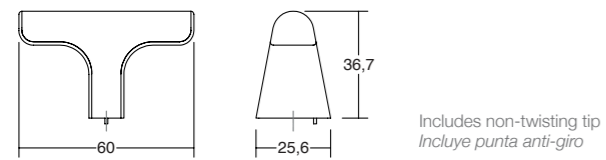

0686 - 160

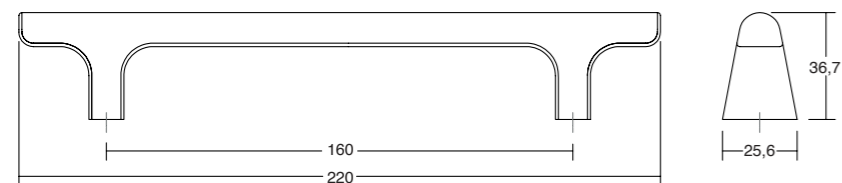

L30 Brushed black Negro cepillado	L618 Brushed brass cava Latón cava cepillado	L619 Brushed bronze Bronce cepillado	↓	☐
0686060L30	0686060L618	0686060L619	1	25
0686160L30	0686160L618	0686160L619	2	25

0695 **HAKO** WOOD Designer: Steffensen & Würtz **NEW!**



0695 - 76

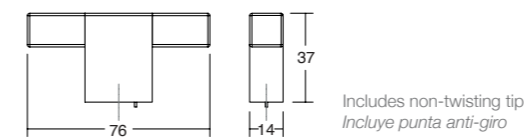

0695 - 160/320

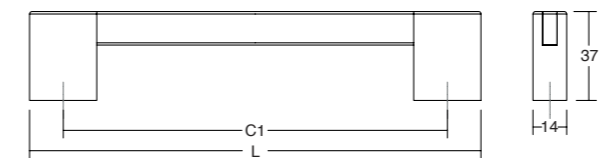

0695 - 960

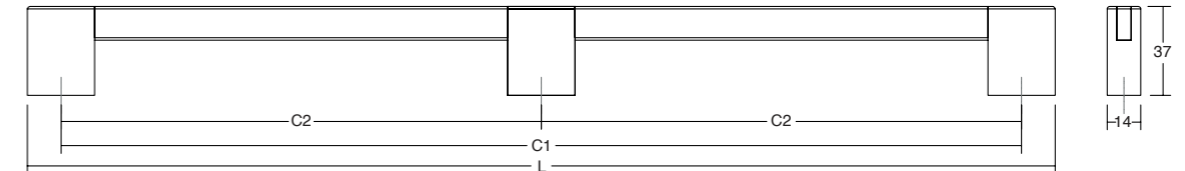

W16 Oak Roble	W17 Walnut Nogal	C	L	↓	☐
0695076W16	0695076W17	-	76	1	25
0695160W16	0695160W17	160	188	2	25
0695320W16	0695320W17	320	348	2	25
0695960W16	0695960W17	960	988	3	10

0705 / 0706 / 0707

HAKO BIG

WOOD

NEW!

① Available with one side system
Disponible con sistema de una cara

② Available with back to back system
Disponible con sistema de doble cara

Designer: Steffensen & Würtz



0705 - 480 / 0706 - 480 / 0707 / 480

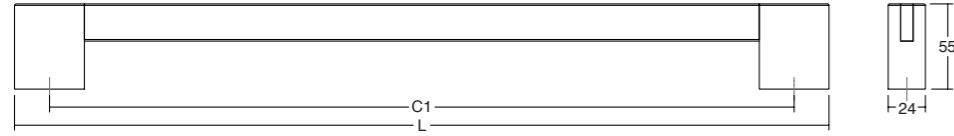

0705 - 960 / 0706 - 960 / 0707 - 960

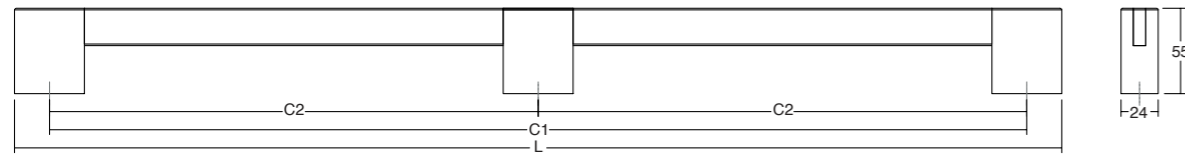

W16 Oak Roble	W17 Walnut Nogal	C1	C2	L	↓	☐
0705480W16	0705480W17	480	-	525	2	2
0705960W16	0705960W17	960	480	1005	3	2
0706480W16	0706480W17	480	-	525	2	2 ①
0706960W16	0706960W17	960	480	1005	3	2 ①
0707480W16	0707480W17	480	-	525	2	1 ②
0707960W16	0707960W17	960	480	1005	3	1 ②

0698

CANO

WOOD

Designer: Kaschkasch

NEW!

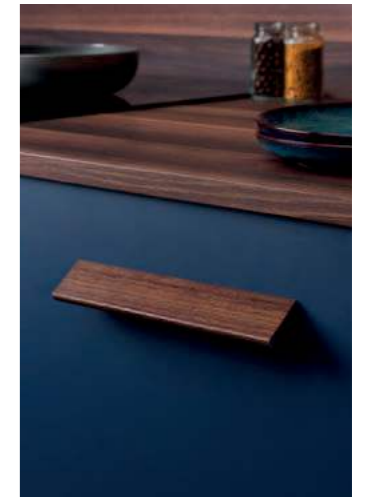

0698 - 160/320

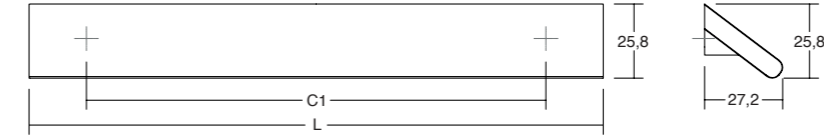

0698 - 1024

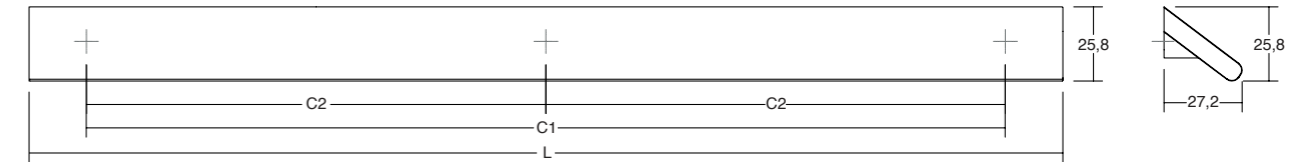

W16 Oak Roble	W17 Walnut Nogal	WM2 Oak matt black lacquered Roble lacado negro mate	W00 Raw oak Roble crudo	C1	C2	L	↓	☐
0698160W16	0698160W17	0698160WM2	0698160W00	160	-	200	2	25
0698320W16	0698320W17	0698320WM2	0698320W00	320	-	360	2	25
06981024W16	06981024W17	06981024WM2	06981024W00	1024	512	1100	3	10

0696

DROPP

ALUMINIUM

Designer: Ilja Huber

NEW!

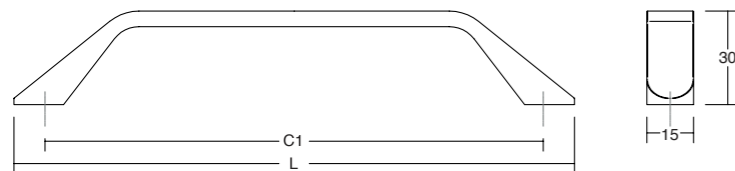

L23 Brushed nickel Níquel cepillado	LM1 Matt white Blanco mate	LM2 Matt black Negro mate	C1	L	↓	☐
0696064L23	0696064LM1	0696064LM2	64	84	2	25
0696160L23	0696160LM1	0696160LM2	160	180	2	25

0628

MOON

ALUMINIUM

Designer: Ilja Huber

NEW!

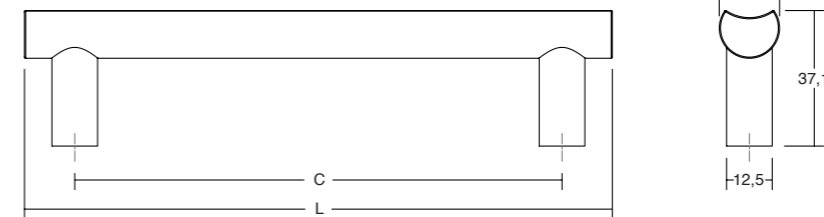
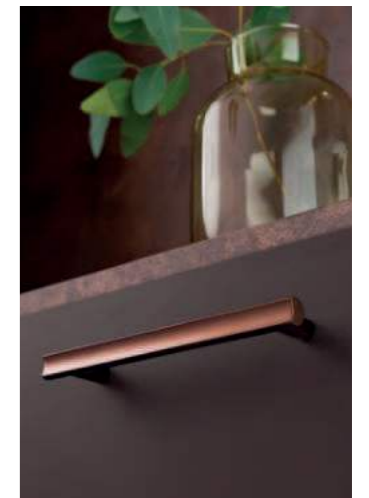

L24 Stainless steel look Inox look	L618 Brushed brass cava Laton cava cepillado	L30 Brushed black Negro cepillado	L619 Brushed bronze Bronce cepillado	C	L	↓	☐
0628160L24	0628160L618	0628160L30	0628160L619	160	193	2	25
0628320L24	0628320L618	0628320L30	0628320L619	320	353	2	25

0700 CASEY

ALUMINIUM

Designer: Alexis Vivet

NEW!



0700 - 60

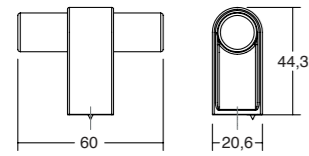

0700 - 192/320

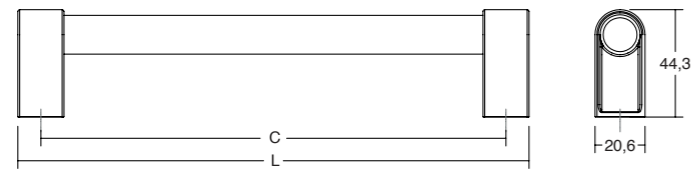

LMT2709 (ZMT27+L09) Textured lava black + Matt black Negro lava texturizado + Negro mate	LMT2703 (ZMT27+L03) Textured lava black + Polished titanium black Negro lava texturizado + Negro titanio brillo	LMT4119(ZMT41+L19) Textured metallic brown + Matt bronze Marrón metal texturizado + Bronce mate	C	L	↓	☐
0700060LMT2709	0700060LMT2703	0700060LMT4119	-	60	1	25
0700192LMT2709	0700192LMT2703	0700192LMT4119	192	211	2	25
0700320LMT2709	0700320LMT2703	0700320LMT4119	320	339	2	25

0636 POINT

ALUMINIUM

Designer: Patricia Roig



0636 - 960

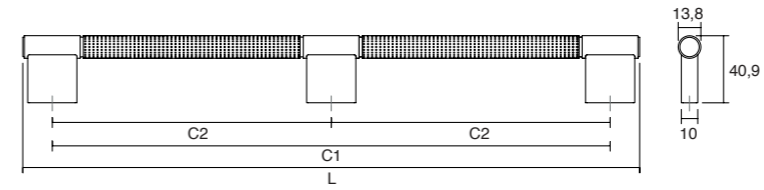

0636 - 192/320

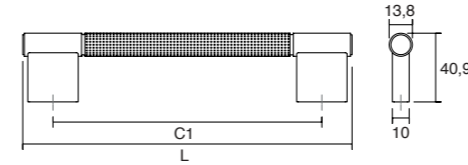

0636 - 110

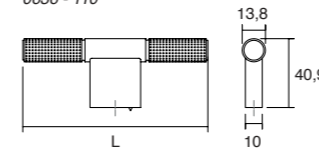

0636 - 040

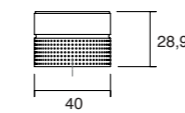

Includes non-twisting tip
Incluye punta anti-giro

L30 Brushed black Negro cepillado	L33 Titanium black Negro titanio	L618 Brushed brass cava Latón cava cepillado	C1	C2	L	↓	☐
0636040L30	0636040L33	0636040L618	-	-	Ø40	1	25
0636110L30	0636110L33	0636110L618	-	-	110	1	25
0636192L30	0636192L33	0636192L618	192	-	228	2	25
0636320L30	0636320L33	0636320L618	320	-	356	2	25
0636960L30	0636960L33	0636960L618	960	480	996	3	10

0701 / 0702 / 0703 CASEY BIG

ALUMINIUM

NEW!

Designer: Alexis Vivet

Available with one side system
Disponible con sistema de una cara

Available with back to back system
Disponible con sistema de doble cara

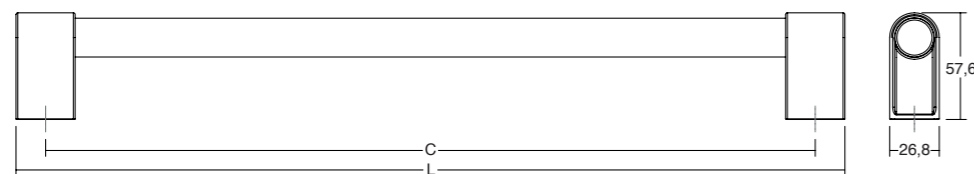

LMT2709 (ZMT27+L09) Textured lava black + Matt black Negro lava texturizado + Negro mate	LMT2703 (ZMT27+L03) Textured lava black + Polished titanium black Negro lava texturizado + Negro titanio brillo	LMT4119(ZMT41+L19) Textured metallic brown + Matt bronze Marrón metal texturizado + Bronce mate	C	L	↓	☐
0701416LMT2709	0701416LMT2703	0701416LMT4119	416	448	2	2
0701736LMT2709	0701736LMT2703	0701736LMT4119	736	768	2	2
0702416LMT2709	0702416LMT2703	0702416LMT4119	416	448	2	2
0702736LMT2709	0702736LMT2703	0702736LMT4119	736	768	2	2
0703416LMT2709	0703416LMT2703	0703416LMT4119	416	448	2	1
0703736LMT2709	0703736LMT2703	0703736LMT4119	736	768	2	1

0627 FUSION

ZAMAK

Designer: Ilja Huber



0627 - 160/320

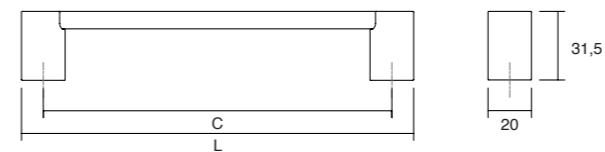

0627 - 058

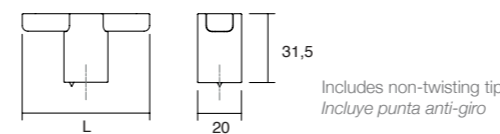

Includes non-twisting tip
Incluye punta anti-giro

Z33 Titanium black Negro titanio	Z618 Brushed brass cava Latón cava cepillado	ZM2 Matt black Negro mate	Z03 Polished titanium black Negro titanio brillo	Z05 Polished nickel Níquel brillo	Z07 Polished brass Latón brillo	C	L	↓	☐
0627058Z33	0627058Z618	0627058ZM2	0627058Z03	0627058Z05	0627058Z07	-	58	1	25
0627160Z33	0627160Z618	0627160ZM2	0627160Z03	0627160Z05	0627160Z07	160	180	2	25
0627320Z33	0627320Z618	0627320ZM2	0627320Z03	0627320Z05	0627320Z07	320	340	2	25

0635

LIDD

ZAMAK

Designer: Ilja Huber

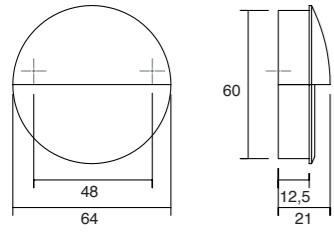

Z23	Z33	Z618	ZM1	ZM2	↓	📦
Brushed nickel <i>Níquel cepillado</i>	Titanium black <i>Negro titanio</i>	Brushed brass cava <i>Latón cava cepillado</i>	Matt white <i>Blanco mate</i>	Matt black <i>Negro mate</i>		
0635048Z23	0635048Z33	0635048Z618	0635048ZM1	0635048ZM2	2	25

0643

LINKK

ALUMINIUM

Designer: Alexis Vivet

0643 - 160/320

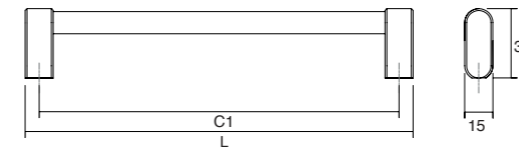

0643 - 1056

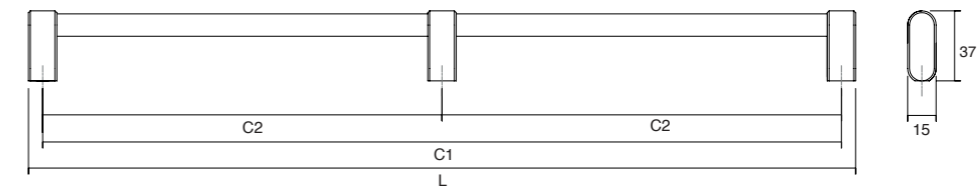

L24	L291	L30	C1	C2	L	↓	📦
Stainless steel look <i>Inox look</i>	Brushed brass <i>Latón cepillado</i>	Brushed black <i>Negro cepillado</i>					
0643160L24	0643160L291	0643160L30	160	-	175	2	25
0643320L24	0643320L291	0643320L30	320	-	335	2	25
06431056L24	06431056L291	06431056L30	1056	528	1071	3	10

0638

PRISM

ZAMAK

Designer: Patricia Roig

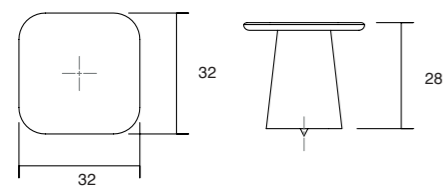

Includes non-twisting tip
Incluye punta anti-giro



Z33	Z618	ZM1	ZM2	Z03	Z05	Z07	↓	📦
Titanium black <i>Negro titanio</i>	Brushed brass cava <i>Latón cava cepillado</i>	Matt white <i>Blanco mate</i>	Matt black <i>Negro mate</i>	Polished titanium black <i>Negro titanio brillo</i>	Polished nickel <i>Níquel brillo</i>	Polished brass <i>Latón brillo</i>		
0638032Z33	0638032Z618	0638032ZM1	0638032ZM2	0638032Z03	0638032Z05	0638032Z07	1	25

0648

OMEGA

ZAMAK

Designer: Kaschkasch

0648 - 160

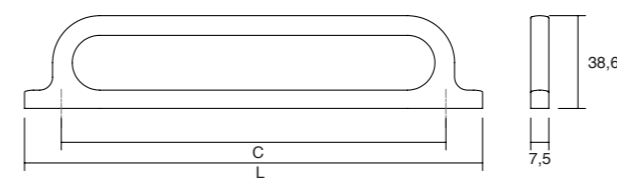

0648 - 32

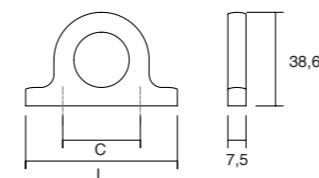

Z618	Z623	ZM2	C	L	↓	📦
Brushed brass cava <i>Latón cava cepillado</i>	Rustic brass <i>Latón rústico</i>	Matt black <i>Negro mate</i>				
0648032Z618	0648032Z623	0648032ZM2	32	62,5	2	25
0648160Z618	0648160Z623	0648160ZM2	160	190,5	2	25

0650 **MOULE** ZAMAK Designer: Kaschkasch

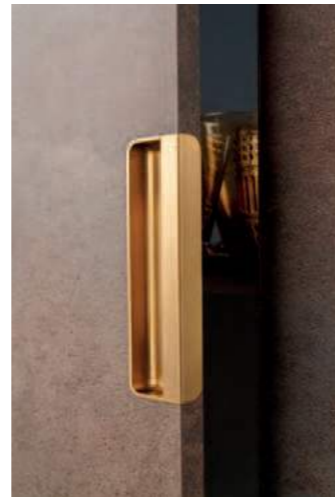
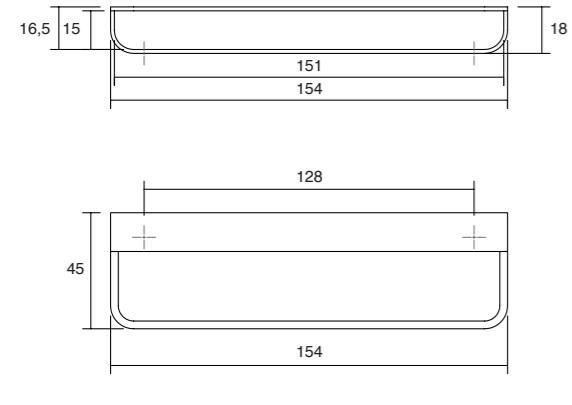

Z33 Titanium black Negro titanio	Z618 Brushed brass cava Latón cava cepillado	ZM1 Matt white Blanco mate	ZM2 Matt black Negro mate	↓
0650128Z33	0650128Z618	0650128ZM1	0650128ZM2	2 25

0645 **RISS** ALUMINIUM Designer: Kaschkasch

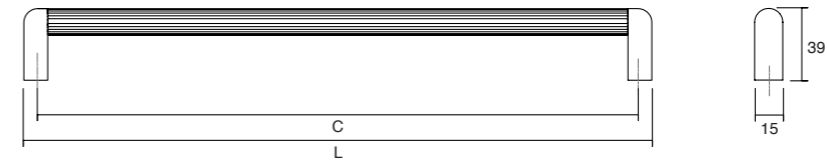

LM1 Matt white Blanco mate	LM2 Matt black Negro mate	LM25 Moss grey Gris musgo	LM31 Forest green Verde forest	LM43 Mocca brown Marrón mocca	LM72 Volcano red Rojo volcanico	LM82 Midnight blue Azul midnight	C	L	↓
0645192LM1	0645192LM2	0645192LM25	0645192LM31	0645192LM43	0645192LM72	0645192LM82	192	207	2 25
0645320LM1	0645320LM2	0645320LM25	0645320LM31	0645320LM43	0645320LM72	0645320LM82	320	335	2 25

0655 **RISS BIG** ALUMINIUM Designer: Kaschkasch

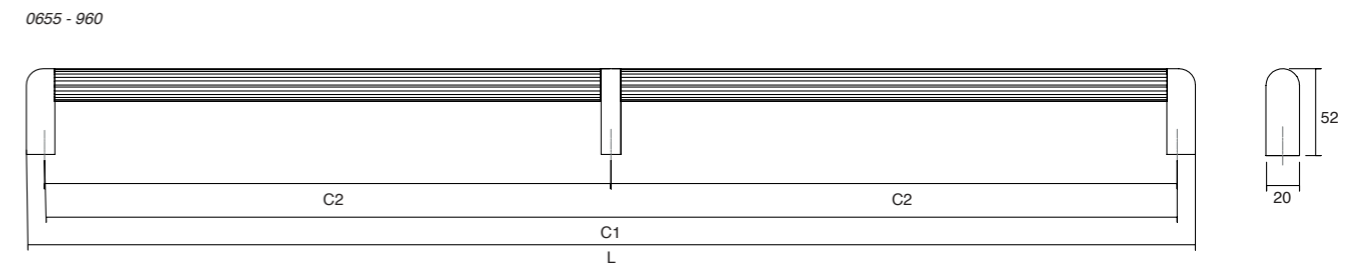
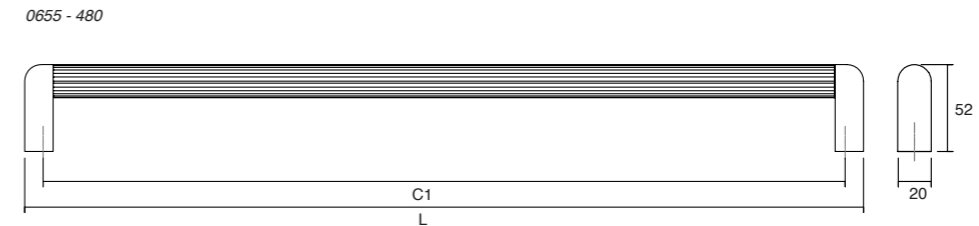

LM1 Matt white Blanco mate	LM2 Matt black Negro mate	LM25 Moss grey Gris musgo	LM31 Forest green Verde forest	LM43 Mocca brown Marrón mocca	LM72 Volcano red Rojo volcanico	LM82 Midnight blue Azul midnight	C1	C2	L	↓
0655480LM1	0655480LM2	0655480LM25	0655480LM31	0655480LM43	0655480LM72	0655480LM82	480	-	502	2 15
0655960LM1	0655960LM2	0655960LM25	0655960LM31	0655960LM43	0655960LM72	0655960LM82	960	480	982	3 10

0603 **LIPP** ZAMAK Designer: Alexis Vivet

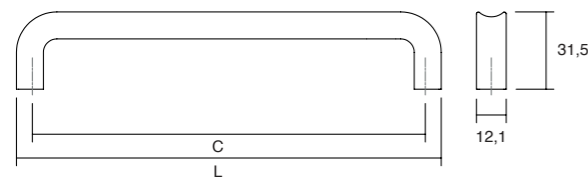

Z618 Brushed brass cava Latón cava cepillado	ZM2 Matt black Negro mate	C	L	↓
0603192Z618	0603192ZM2	192	205	2 25
0603320Z618	0603320ZM2	320	333	2 25

0657 **NOBB** ALUMINIUM Designer: Viefe Studio

0657 - 1056

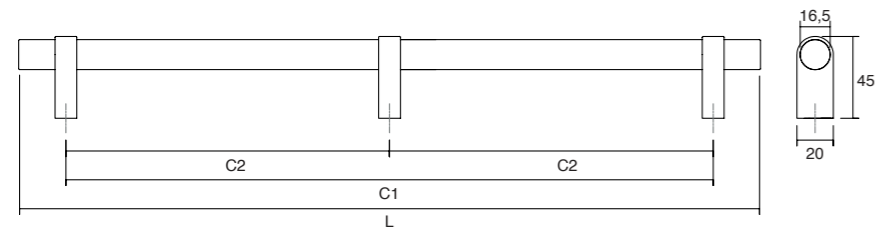

0657 - 192/320

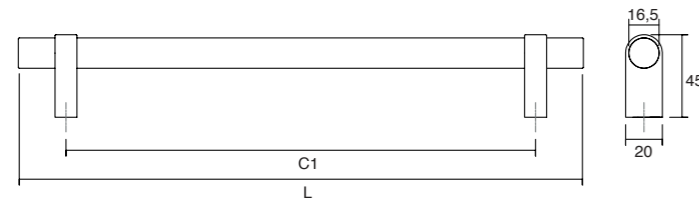

0657 - 052

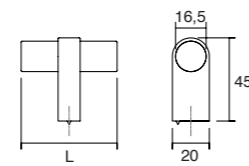

Includes non-twisting tip / Incluye punta anti-giro



L24 Stainless steel look Inox look	L618 Brushed brass cava Latón cava cepillado	L30 Brushed black Negro cepillado	C1	C2	L	↓	☰
0657052L24	0657052L618	0657052L30	-	-	52	1	25
0657192L24	0657192L618	0657192L30	192	-	244	2	25
0657320L24	0657320L618	0657320L30	320	-	372	2	25
06571056L24	06571056L618	06571056L30	1056	528	1108	3	10

0658 **DUO** ALUMINIUM + WOOD Designer: Ilja Huber

Certified wood
Madera certificada

0658 - 160/320

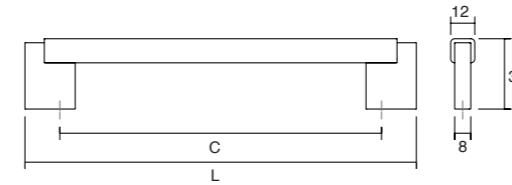

NM2716 Lava black + Oak Negro lava + roble	NM2717 Lava black + Walnut Negro lava + Nogal	NM2M2 Matt black + Oak matt black lacquered Negro mate + Roble lacado negro mate	C	L	↓	☰
0658160NM2716	0658160NM2717	0658160NM2M2	160	194,6	2	25
0658320NM2716	0658320NM2717	0658320NM2M2	320	354,6	2	25

0629 / 0662 / 0663 **MOON BIG** ALUMINIUM Designer: Ilja Huber

Available with one side system
Disponible con sistema de una cara

Available with back to back system
Disponible con sistema de doble cara

0629 - 384 / 0662 - 384 / 0663 - 384

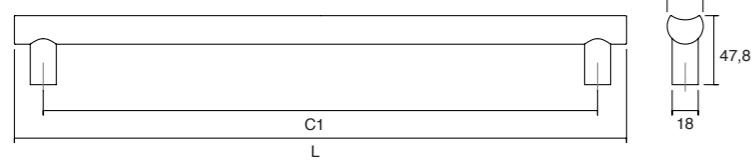

0629 - 1056 / 0662 - 1056 / 0663 - 1056

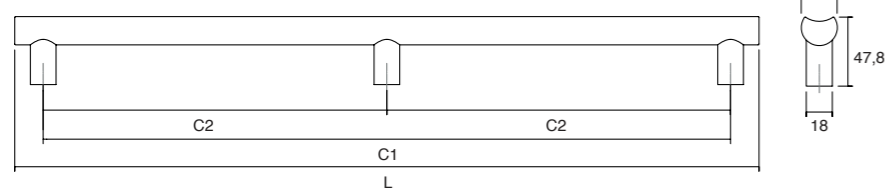

L24 Stainless steel look Inox look	L618 Brushed brass cava Latón cava cepillado	L30 Brushed black Negro cepillado	NEW! L619 Brushed bronze Bronce cepillado	C1	C2	L	↓	☰
0629384L24	0629384L618	0629384L30	0629384L619	384	-	424	2	15
06291056L24	06291056L618	06291056L30	06291056L619	1056	528	1096	3	10
0662384L24	0662384L618	0662384L30	0662384L619	384	-	424	2	2
06621056L24	06621056L618	06621056L30	06621056L619	1056	528	1096	3	2
0663384L24	0663384L618	0663384L30	0663384L619	384	-	424	2	1
06631056L24	06631056L618	06631056L30	06631056L619	1056	528	1096	3	1

0659 / 0668 / 0670 **DUO BIG** ALUMINIUM + WOOD Designer: Ilja Huber

Available with one side system
Disponible con sistema de una cara

Available with back to back system
Disponible con sistema de doble cara

Certified wood
Madera certificada

0659 - 1016 / 0668 - 1016 / 0670 - 1016

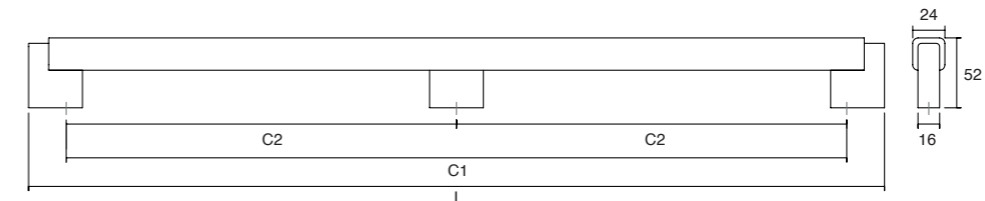

0659 - 536 / 0668 - 536 / 0670 - 536

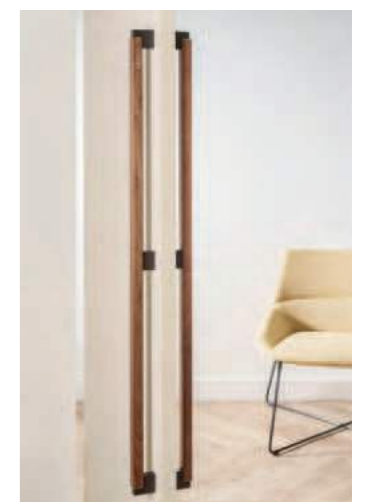
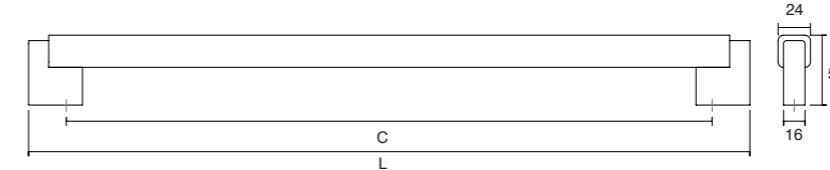

NM2716 Lava black + Oak Negro lava + roble	NM2717 Lava black + Walnut Negro lava + Nogal	NM2M2 Matt black + Oak matt black lacquered Negro mate + Roble lacado negro mate	C1	C2	L	↓	☰
0659480NM2716	0659480NM2717	0659480NM2M2	480	-	536	2	2
0659960NM2716	0659960NM2717	0659960NM2M2	960	480	1016	3	2
0668480NM2716	0668480NM2717	0668480NM2M2	480	-	536	2	2
0668960NM2716	0668960NM2717	0668960NM2M2	960	480	1016	3	2
0670480NM2716	0670480NM2717	0670480NM2M2	480	-	536	2	1
0670960NM2716	0670960NM2717	0670960NM2M2	960	480	1016	3	1

0664 / 0665 / 0671

LUV BIG

WOOD Designer: Kaschkasch

Available with one side system
Disponible con sistema de una cara

Available with back to back system
Disponible con sistema de doble cara

Certified wood
Madera certificada

0664 - 992 / 0665 - 992 / 0671 - 992

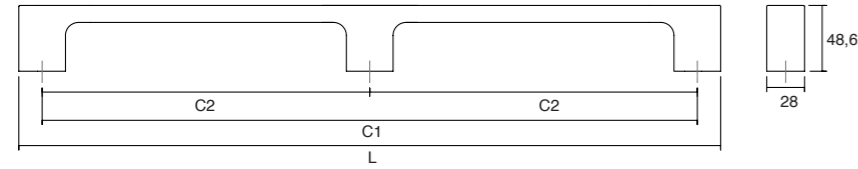

0664 - 384 / 0665 - 384 / 0671 - 384

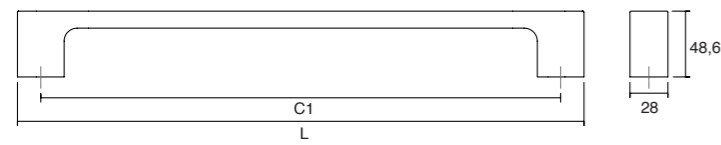

W16	W17	WM2	W00	C1	C2	L	↓	☐
Oak	Walnut	Oak matt black lacquered	Raw oak					
Roble	Nogal	Roble lacado negro mate	Roble crudo					
0664384W16	0664384W17	0664384WM2	0664384W00	384	-	418,5	2	2
0664992W16	0664992W17	0664992WM2	0664992W00	992	496	1026,5	3	2
0665384W16	0665384W17	0665384WM2	0665384W00	384	-	418,5	2	2
0665992W16	0665992W17	0665992WM2	0665992W00	992	496	1026,5	3	2
0671384W16	0671384W17	0671384WM2	0671384W00	384	-	418,5	2	1
0671992W16	0671992W17	0671992WM2	0671992W00	992	496	1026,5	3	1



0621 **RILLE MINI**

ALUMINIUM

Designer: Patricia Roig

0621 - 160/320

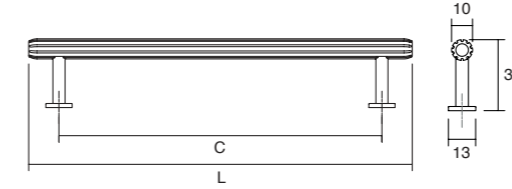

0621 - 055

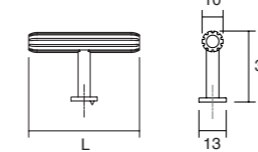

Includes non-twisting tip
Incluye punta anti-giro

L05	L24	L291	L30	C	L	↓	☐
Polished nickel	Stainless steel look	Brushed brass	Brushed black				
Níquel brillo	Inox look	Latón cepillado	Negro cepillado				
0621055L05	0621055L24	0621055L291	0621055L30	-	55	1	25
0621160L05	0621160L24	0621160L291	0621160L30	160	190	2	25
0621320L05	0621320L24	0621320L291	0621320L30	320	350	2	25



0536

LUV

ZAMAK

Designer: Kaschkasch

0536 - 192 / 320

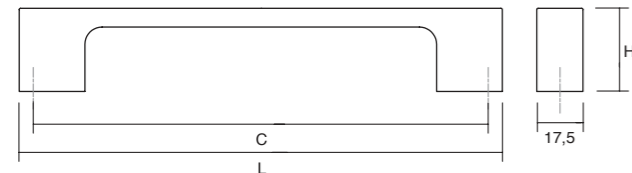

0536 - 017

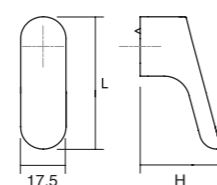

Includes non-twisting tip
Incluye punta anti-giro

Z23	Z618	ZM1	ZM2	C	L	H	↓	☐
Brushed nickel	Brushed brass cava	Matt white	Matt black					
Níquel cepillado	Latón cava cepillado	Blanco mate	Negro mate					
0536017Z23	0536017Z618	0536017ZM1	0536017ZM2	-	51,2	31,1	1	25
0536192Z23	0536192Z618	0536192ZM1	0536192ZM2	192	202	30,4	2	25
0536320Z23	0536320Z618	0536320ZM1	0536320ZM2	320	330	30,4	2	25



0528

RILLE

ALUMINIUM

Designer: Patricia Roig

0528 - 160 / 320 / 480

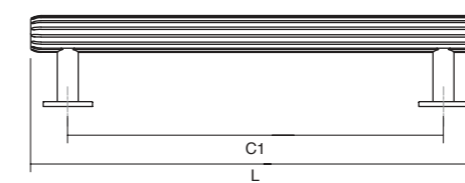

0528 - 055

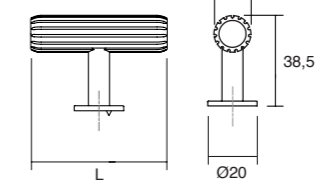

Includes non-twisting tip
Incluye punta anti-giro

0528 - 992

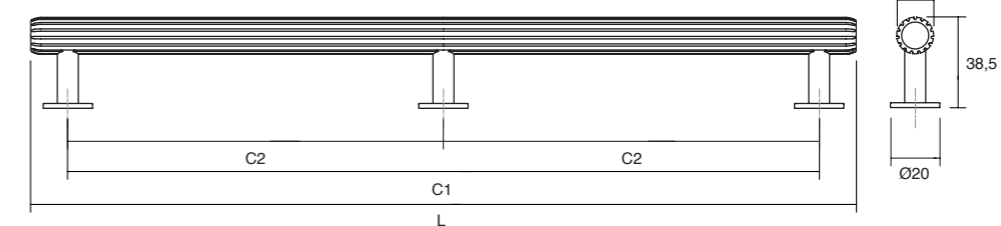

L24	L291	L30	C1	C2	L	↓	☐
Stainless steel look	Brushed brass	Brushed black					
Inox look	Latón cepillado	Negro cepillado					
0528055L24	0528055L291	0528055L30	-	-	55	1	25
0528160L24	0528160L291	0528160L30	160	-	190	2	25
0528320L24	0528320L291	0528320L30	320	-	350	2	25
0528480L24	0528480L291	0528480L30	480	-	510	2	25
0528992L24	0528992L291	0528992L30	992	496	1022	3	15



0487 **PURA** ZAMAK Designer: Balutto Associati

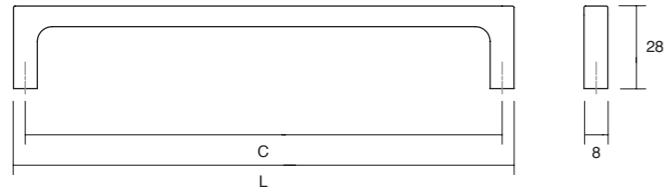

Z01	Z03	Z06	Z07	Z23	Z618	ZM2	C	L	↓	☐
Polished chrome <i>Cromo brillo</i>	Polished titanium black <i>Negro titanio brillo</i>	Polished copper <i>Cobre brillo</i>	Polished brass <i>Latón brillo</i>	Brushed nickel <i>Níquel cepillado</i>	Brushed brass cava <i>Latón cava cepillado</i>	Matt black <i>Negro mate</i>				
0487160Z01	0487160Z03	0487160Z06	0487160Z07	0487160Z23	0487160Z618	0487160ZM2	160	168	2	25
0487256Z01	0487256Z03	0487256Z06	0487256Z07	0487256Z23	0487256Z618	0487256ZM2	256	264	2	25

0597 **PLIÉ** ZAMAK Designer: Teruel & Paré

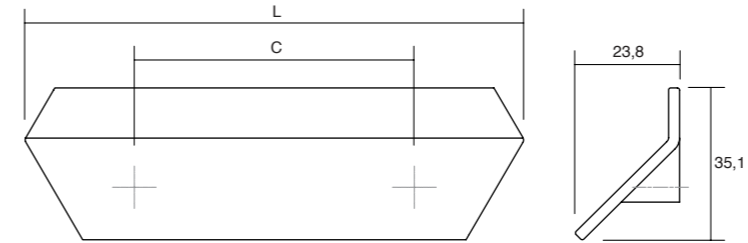

ZM2	ZM23	ZM41	C	L	↓	☐
Matt black <i>Negro mate</i>	Metal grey <i>Gris metal</i>	Metal brown <i>Marrón metal</i>				
0597064ZM2	0597064ZM23	0597064ZM41	64	114	2	25
0597160ZM2	0597160ZM23	0597160ZM41	160	210	2	25

0590 **BELT** ZAMAK Designer: Kaschkasch

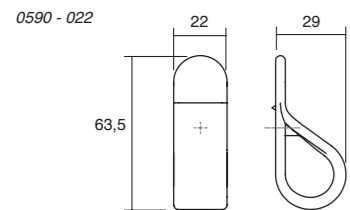
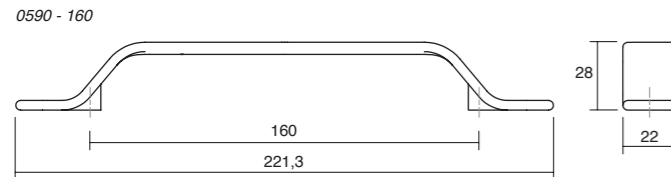

Includes non-twisting tip / Incluye punta anti-giro

ZM1	ZM2	ZM25	ZM31	ZM43	ZM72	↓	☐
Matt white <i>Blanco mate</i>	Matt black <i>Negro mate</i>	Moss grey <i>Gris musgo</i>	Forest green <i>Verde forest</i>	Mocca brown <i>Marrón mocca</i>	Volcano red <i>Rojo volcano</i>		
0590022ZM1	0590022ZM2	0590022ZM25	0590022ZM31	0590022ZM43	0590022ZM72	1	25
0590160ZM1	0590160ZM2	0590160ZM25	0590160ZM31	0590160ZM43	0590160ZM72	2	25

0600 **WING** ALUMINIUM Designer: Alexis Vivet

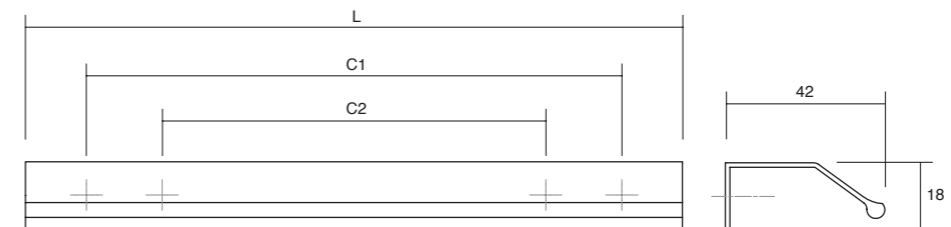

L24	L30	L613	L618	C1	C2	L	↓	☐
Stainless steel look <i>Inox look</i>	Brushed black <i>Negro cepillado</i>	Antique bronze <i>Bronce antiguo</i>	Brushed brass cava <i>Latón cava cepillado</i>					
0600064L24	0600064L30	0600064L613	0600064L618	64	-	100	2	25
0600128L24	0600128L30	0600128L613	0600128L618	128	-	200	2	25
0600256L24	0600256L30	0600256L613	0600256L618	256	-	350	2	25
06001120L24	06001120L30	06001120L613	06001120L618	1120	384	1200	4	15



0591 **ETO** ALUMINIUM + WOOD Designer: Kaschkasch

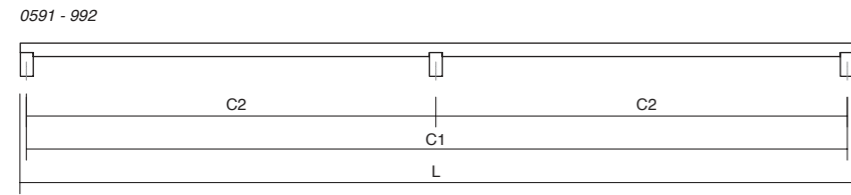
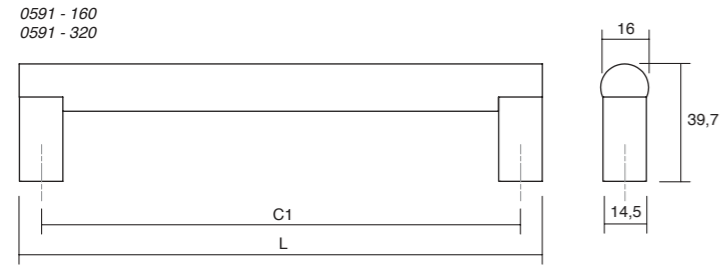

NM2716	NM2717	NM2M2	C1	C2	L	↓	📦
Lava black + Oak Negro lava + Roble	Lava black + Walnut Negro lava + Nogal	Matt black + Ash matt black lacquered Negro mate + Fresno lacado negro mate					
0591160NM2716	0591160NM2717	0591160NM2M2	160	-	174,6	2	25
0591320NM2716	0591320NM2717	0591320NM2M2	320	-	334,6	2	25
0591992NM2716	0591992NM2717	0591992NM2M2	992	496	1006,6	3	15



0613 **FLAPP WOOD** WOOD Designer: Frank Person

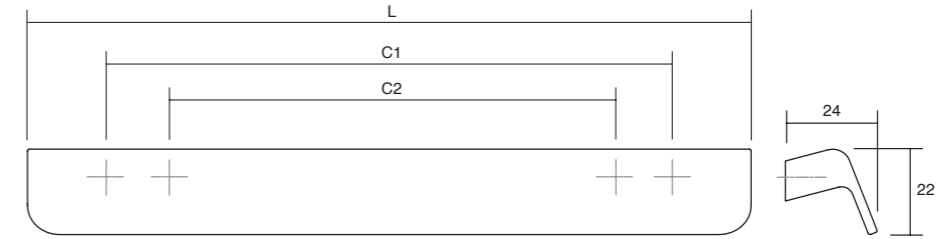

NEW!

W16	W17	W00	C1	C2	L	↓	📦
Oak Roble	Walnut Nogal	Oak raw Roble crudo					
0613032W16	0613032W17	0613032W00	32	-	70	2	25
0613160W16	0613160W17	0613160W00	160	-	200	2	25
06131056W16	06131056W17	06131056W00	1056	416	1100	4	15



0610 **FLAPP** ALUMINIUM Designer: Frank Person

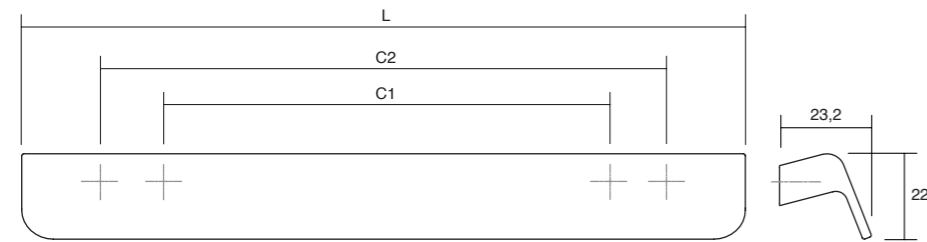

L24	L30	L618	C1	C2	L	↓	📦
Stainless steel look Inox look	Brushed black Negro cepillado	Brushed brass cava Latón cava cepillado					
0610032L24	0610032L30	0610032L618	32	-	70	2	25
0610160L24	0610160L30	0610160L618	128	160	200	4	25
0610256L24	0610256L30	0610256L618	256	-	350	2	25
06101056L24	06101056L30	06101056L618	416	1056	1100	4	15



0601 **OH! Wood** WOOD Designer: Alexis Vivet

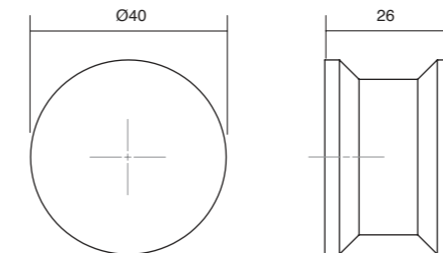

W16	W17	WM2	↓	📦
Oak Roble	Walnut Nogal	Ash matt black lacquered Fresno lacado negro mate		
0601040W16	0601040W17	0601040WM2	1	25

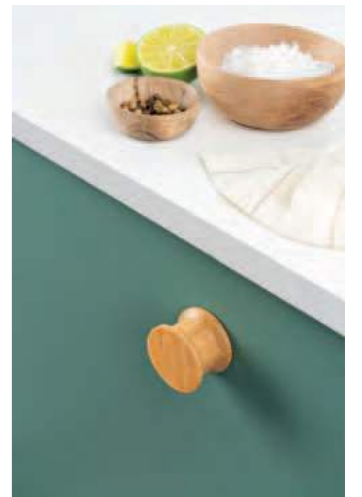

0601 **OH! Zamak** ZAMAK Designer: Alexis Vivet

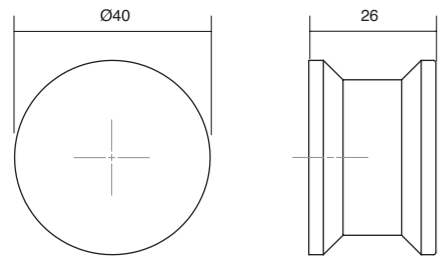

Z23	Z618	ZM2	
Brushed nickel <i>Níquel cepillado</i>	Brushed brass cava <i>Latón cava cepillado</i>	Matt black <i>Negro mate</i>	↓
0601040Z23	0601040Z618	0601040ZM2	1 25



0608 **QUART MINI** ZAMAK Designer: Frank Person



Z618	Z623	ZM2	
Brushed brass cava <i>Latón cava cepillado</i>	Rustic brass <i>Latón rústico</i>	Matt black <i>Negro mate</i>	↓
0608026Z618	0608026Z623	0608026ZM2	1 25
0608128Z618	0608128Z623	0608128ZM2	2 25

Includes non-twisting tip
Incluye punta anti-giro



0602 **VALLEY** ZAMAK Designer: Alexis Vivet

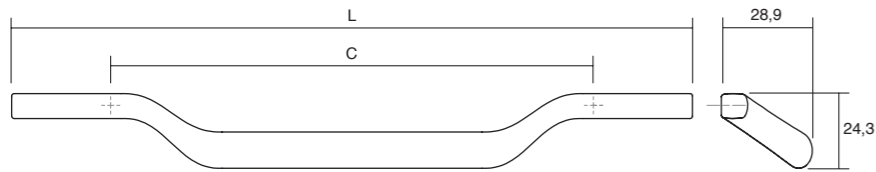

Z03	Z07	Z618	ZM2	C	L	↓
Polished titanium black <i>Negro titanio brillo</i>	Polished brass <i>Latón brillo</i>	Brushed brass cava <i>Latón cava cepillado</i>	Matt black <i>Negro mate</i>			
0602160Z03	0602160Z07	0602160Z618	0602160ZM2	160	223	2 25
0602256Z03	0602256Z07	0602256Z618	0602256ZM2	256	330	2 25



0616 **QUART** ZAMAK Designer: Frank Person

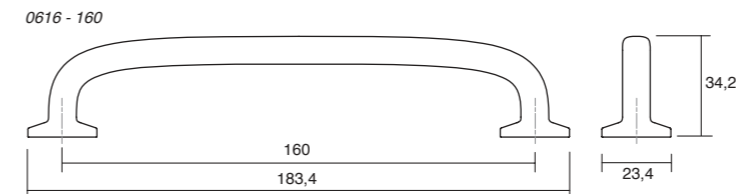

Z618	Z623	ZM2	
Brushed brass cava <i>Latón cava cepillado</i>	Rustic brass <i>Latón rústico</i>	Matt black <i>Negro mate</i>	↓
0616034Z618	0616034Z623	0616034ZM2	1 25
0616160Z618	0616160Z623	0616160ZM2	2 25

Includes non-twisting tip
Incluye punta anti-giro



0604 **PRISMA** ZAMAK Designer: Alexis Vivet

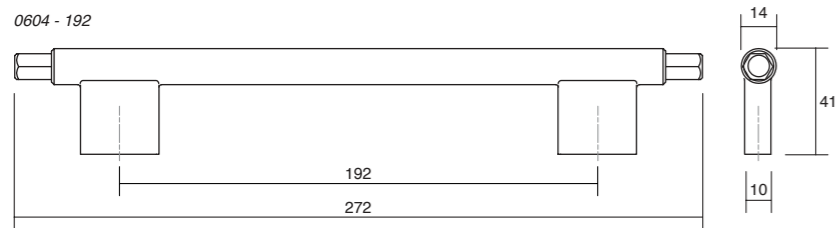

ZM2	Z623	
Matt black <i>Negro mate</i>	Rustic brass <i>Latón rústico</i>	↓
0604078ZM2	0604078Z623	1 25
0604192ZM2	0604192Z623	2 15

Includes non-twisting tip
Incluye punta anti-giro



0614 **EQUIS** ZAMAK Designer: Patricia Roig

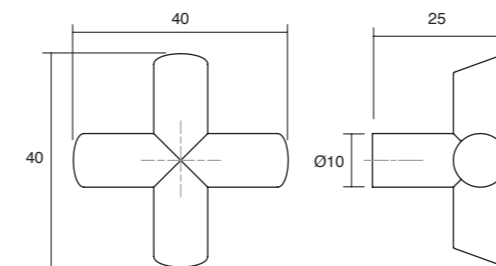

Z01	Z03	Z06	Z07	ZM1	ZM2	
Polished chrome <i>Cromo brillo</i>	Polished titanium black <i>Negro titanio brillo</i>	Polished copper <i>Cobre brillo</i>	Polished brass <i>Latón brillo</i>	Matt white <i>Blanco mate</i>	Matt black <i>Negro mate</i>	↓
0614040Z01	0614040Z03	0614040Z06	0614040Z07	0614040ZM1	0614040ZM2	1 25

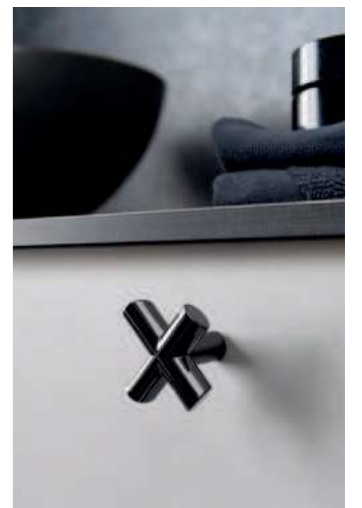

0530 **DISC Wood**

WOOD

Designer: Balutto Associati

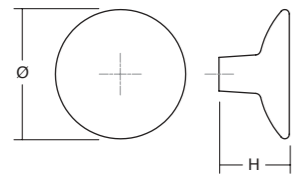

W16	W17	WM2	Ø	H	↓	☐
Oak	Walnut	Ash matt black lacquered				
Roble	Nogal	Fresno lacado negro mate				
0530038W16	0530038W17	0530038WM2	38	20,4	1	25
0530050W16	0530050W17	0530050WM2	50	27	1	25

0538 **CONIC Zamak**

ZAMAK

Designer: Kaschkasch

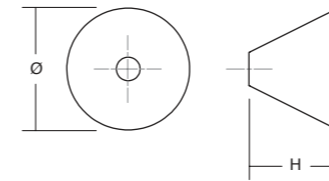
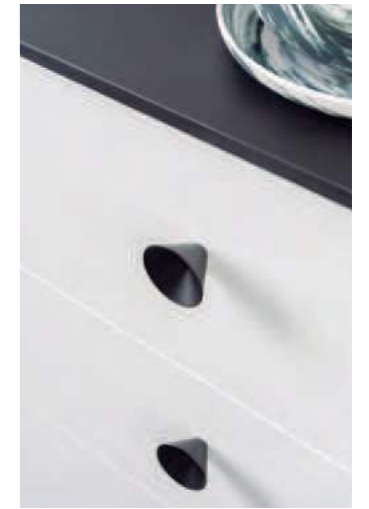

ZM1	ZM2	ZM25	Ø	H	↓	☐
Matt white	Matt black	Moss grey				
Blanco mate	Negro mate	Gris musgo				
0538029ZM1	0538029ZM2	0538029ZM25	29,4	22	1	25
0538043ZM1	0538043ZM2	0538043ZM25	43	25	1	25

0530 **DISC Zamak**

ZAMAK

Designer: Balutto Associati

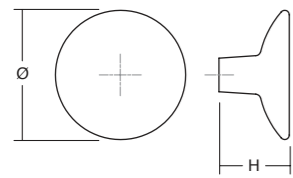

Z23	Z618	ZM1	ZM2	Ø	H	↓	☐
Brushed nickel	Brushed brass cava	Matt white	Matt black				
Níquel cepillado	Latón cava cepillado	Blanco mate	Negro mate				
0530038Z23	0530038Z618	0530038ZM1	0530038ZM2	38	20,4	1	25
0530050Z23	0530050Z618	0530050ZM1	0530050ZM2	50	27	1	25

0556 **DIPO**

ZAMAK

Designer: Bernat Llloch

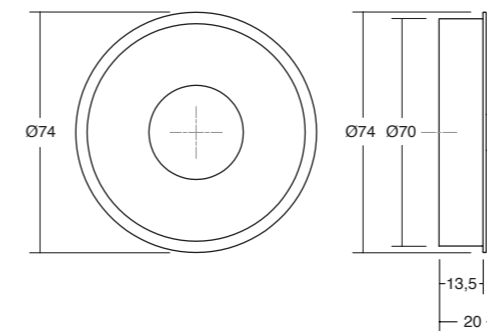

ZM1	ZM2	ZM25	↓	☐
Matt white	Matt black	Moss grey		
Blanco mate	Negro mate	Gris musgo		
0556070ZM1	0556070ZM2	0556070ZM25	1	25

0538 **CONIC Wood**

WOOD

Designer: Kaschkasch

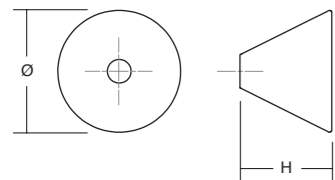

W16	W17	WM2	Ø	H	↓	☐
Oak	Walnut	Ash matt black lacquered				
Roble	Nogal	Fresno lacado negro mate				
0538029W16	0538029W17	0538029WM2	29,4	22	1	25
0538043W16	0538043W17	0538043WM2	43	25	1	25

0552 **RIM**

ZAMAK Designer: Bernat Llorch

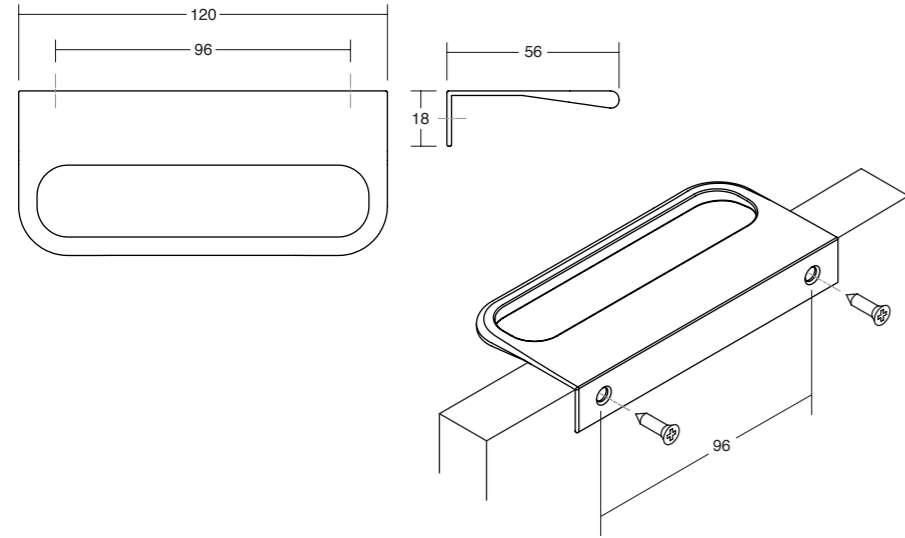

Z23	Z618	ZM1	ZM2	ZM25	↓	☐
Brushed nickel	Brushed brass cava	Matt white	Matt black	Moss grey		
Níquel cepillado	Latón cava cepillado	Blanco mate	Negro mate	Gris musgo		
0552096Z23	0552096Z618	0552096ZM1	0552096ZM2	0552096ZM25	2	25

0553 **OTO**

ZAMAK Designer: Bernat Llorch

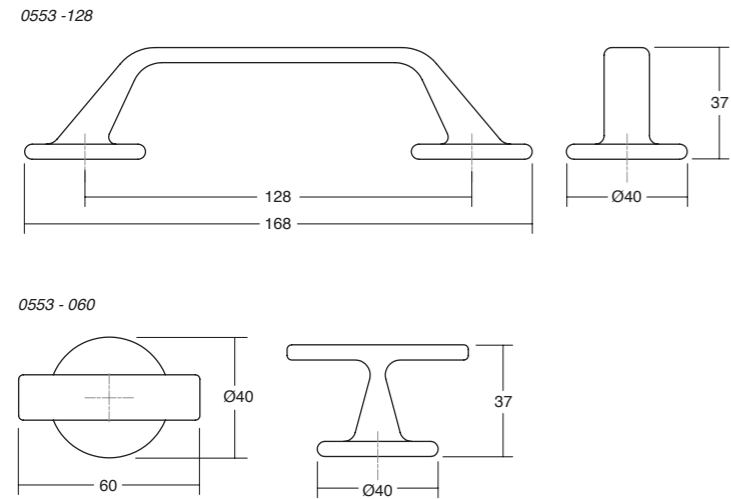

ZM22	↓	☐
Textured black		
Negro texturizado		
0553060ZM22	1	25
0553128ZM22	2	25

0542 **FOLD**

ZAMAK Designer: Teruel & Paré

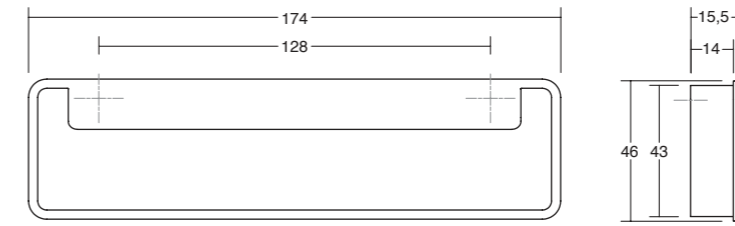

Z23	Z618	ZM1	ZM2	↓	☐
Brushed nickel	Brushed brass cava	Matt white	Matt black		
Níquel cepillado	Latón cava cepillado	Blanco mate	Negro mate		
0542128Z23	0542128Z618	0542128ZM1	0542128ZM2	2	25

0588 **ARPA PLATE**

ALUMINIUM Designer: Viefe Studio

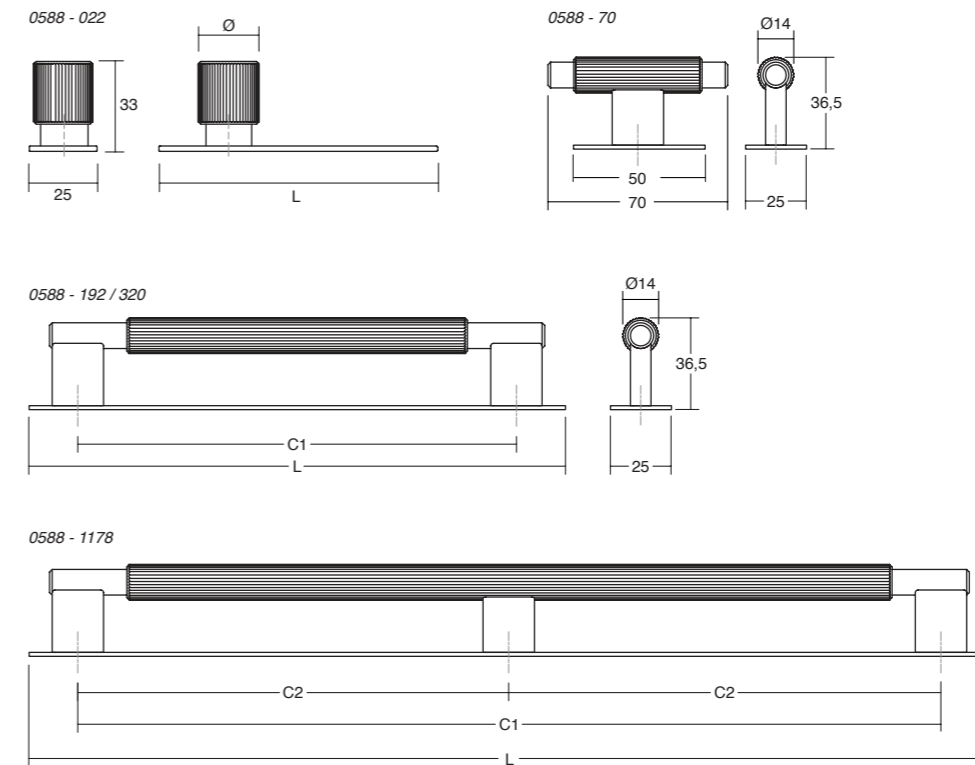

L24	L291	L30	L623	C1	C2	L	Ø	↓	☐
Stainless steel look	Brushed brass	Brushed black	Antique brass						
Inox look	Latón cepillado	Negro cepillado	Latón antiguo						
0588022L24	0588022L291	0588022L30	0588022L623	-	-	100	22	1	25
0588070L24	0588070L291	0588070L30	0588070L623	-	-	70	-	1	25
0588192L24	0588192L291	0588192L30	0588192L623	192	-	230	-	2	25
0588320L24	0588320L291	0588320L30	-	320	-	358	-	2	25
05881178L24	05881178L291	05881178L30	-	1178	589	1216	-	3	10

0583 **ARPA** ALUMINIUM Designer: Viefe Studio

0583 - 022

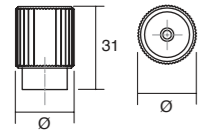

0583 - 70

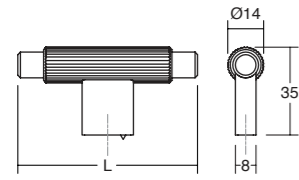

Includes non-twisting tip
Incluye punta anti-giro

0583 - 192 / 320

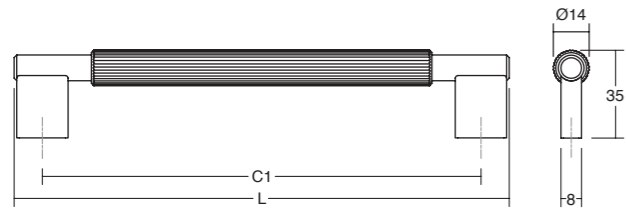

0583 - 1178

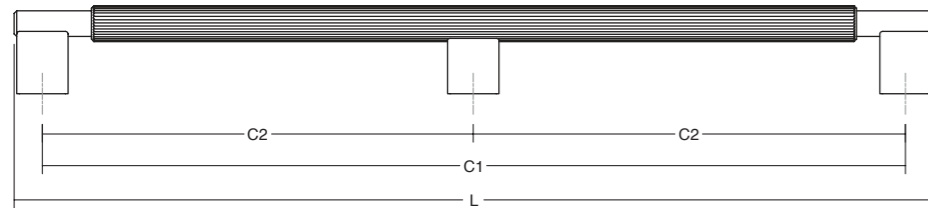

L24	L291	L30	L623	C1	C2	L	Ø	↓	☐
Stainless stl. look Inox look	Brushed brass Latón cepillado	Brushed black Negro cepillado	Rustic brass Latón rústico						
0583022L24	0583022L291	0583022L30	0583022L623	-	-	22	1	25	
0583070L24	0583070L291	0583070L30	0583070L623	-	-	70	-	1	25
0583192L24	0583192L291	0583192L30	0583192L623	192	-	214	-	2	25
0583320L24	0583320L291	0583320L30	-	320	-	342	-	2	25
05831178L24	05831178L291	05831178L30	-	1178	589	1200	-	3	10



0495 **FLOID** ZAMAK Designer: Frank Person

0495 - 035

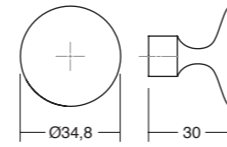

0495 - 128 / 192

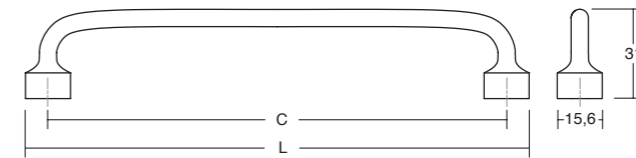

Z28	Z610	Z614	ZM2	C	L	↓	☐
Brushed gold Oro cepillado	Pewter Peltre	Antique brass Latón antiguo	Matt black Negro mate				
0495035Z28	0495035Z610	0495035Z614	0495035ZM2	-	-	1	25
0495128Z28	0495128Z610	0495128Z614	0495128ZM2	128	143,6	2	25
0495192Z28	0495192Z610	0495192Z614	0495192ZM2	192	207,6	2	25

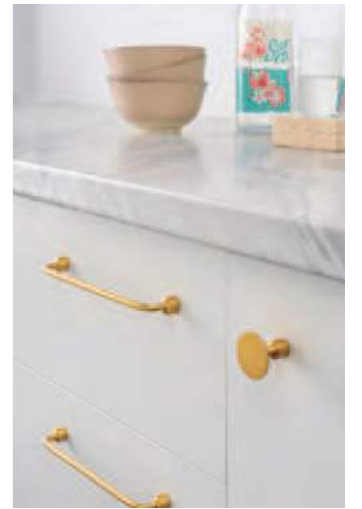

0250 / 0251 **FORMA** ALUMINIUM Designer: 2J Design

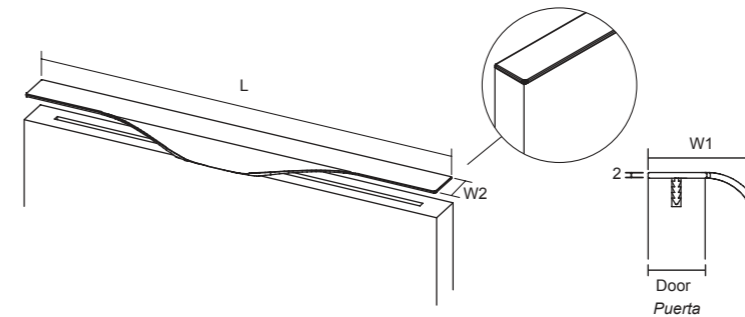

L24	L	W1	W2	☐	Door Puerta	L24	L	W1	W2	☐	Door Puerta
Stain. steel look Inox look						Stain. steel look Inox look					
0250147L24	147	38	19,8	15	19	0251147L24	147	40	21	15	20,5
0250197L24	197	38	19,8	15	19	0251197L24	197	40	21	15	20,5
0250247L24	247	38	19,8	15	19	0251247L24	247	40	21	15	20,5
0250297L24	297	38	19,8	15	19	0251297L24	297	40	21	15	20,5
0250347L24	347	38	19,8	15	19	0251347L24	347	40	21	15	20,5
0250397L24	397	38	19,8	15	19	0251397L24	397	40	21	15	20,5
0250447L24	447	38	19,8	10	19	0251447L24	447	40	21	10	20,5
0250497L24	497	38	19,8	10	19	0251497L24	497	40	21	10	20,5
0250597L24	597	38	19,8	10	19	0251597L24	597	40	21	10	20,5
0250697L24	697	38	19,8	10	19	0251697L24	697	40	21	10	20,5
0250797L24	797	38	19,8	10	19	0251797L24	797	40	21	10	20,5
0250897L24	897	38	19,8	5	19	0251897L24	897	40	21	5	20,5
0250997L24	997	38	19,8	5	19	0251997L24	997	40	21	5	20,5
02501197L24	1197	38	19,8	5	19	02511197L24	1197	40	21	5	20,5

0127 **JEY** ALUMINIUM Designer: Viefe Studio

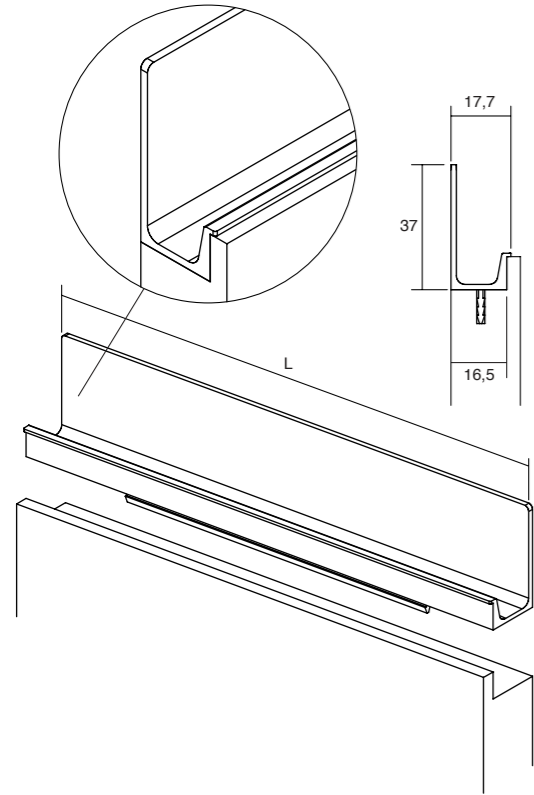

L24 Stainless steel look Inox look	L618 Brushed brass cava Latón cava cepillado	LM1 Matt white Blanco mate	LM2 Matt black Negro mate	L	⊞
0127147L24	0127147L618	0127147LM1	0127147LM2	147	15
0127197L24	0127197L618	0127197LM1	0127197LM2	197	15
0127247L24	0127247L618	0127247LM1	0127247LM2	247	15
0127297L24	0127297L618	0127297LM1	0127297LM2	297	15
0127347L24	0127347L618	0127347LM1	0127347LM2	347	15
0127397L24	0127397L618	0127397LM1	0127397LM2	397	15
0127447L24	0127447L618	0127447LM1	0127447LM2	447	10
0127497L24	0127497L618	0127497LM1	0127497LM2	497	10
0127597L24	0127597L618	0127597LM1	0127597LM2	597	10
0127697L24	0127697L618	0127697LM1	0127697LM2	697	10
0127797L24	0127797L618	0127797LM1	0127797LM2	797	10
0127897L24	0127897L618	0127897LM1	0127897LM2	897	5
0127997L24	0127997L618	0127997LM1	0127997LM2	997	5
01271197L24	01271197L618	01271197LM1	01271197LM2	1197	5
-	-	01273000LM1	01273000LM2	3000	15 *

*Available only in M1 and M2 finishes. Three metre profiles are delivered according to the units of the original packaging and cannot be sold separately. / Disponible solo en los acabados M1 y M2. Las barras de tres metros se sirven según las cantidades del embalaje original y no se pueden servir por separado.

0163 **JEY2** ALUMINIUM Designer: Viefe Studio

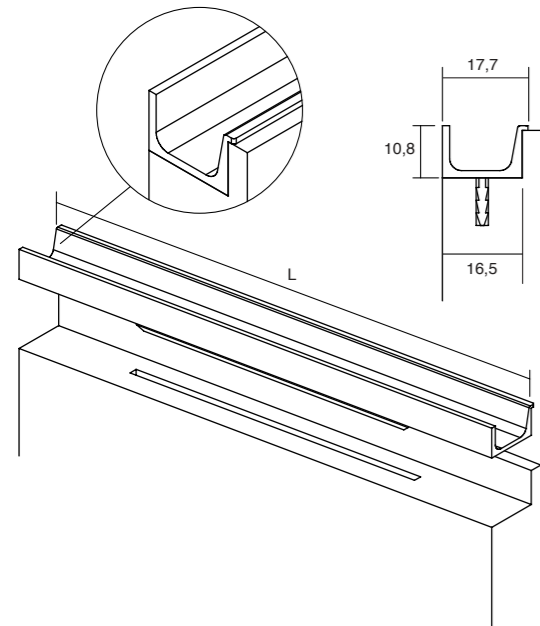

L24 Stainless steel look Inox look	L618 Brushed brass cava Latón cava cepillado	LM1 Matt white Blanco mate	LM2 Matt black Negro mate	L	⊞
0163147L24	0163147L618	0163147LM1	0163147LM2	147	15
0163197L24	0163197L618	0163197LM1	0163197LM2	197	15
0163247L24	0163247L618	0163247LM1	0163247LM2	247	15
0163297L24	0163297L618	0163297LM1	0163297LM2	297	15
0163347L24	0163347L618	0163347LM1	0163347LM2	347	15
0163397L24	0163397L618	0163397LM1	0163397LM2	397	15
0163447L24	0163447L618	0163447LM1	0163447LM2	447	10
0163497L24	0163497L618	0163497LM1	0163497LM2	497	10
0163597L24	0163597L618	0163597LM1	0163597LM2	597	10
0163697L24	0163697L618	0163697LM1	0163697LM2	697	10
0163797L24	0163797L618	0163797LM1	0163797LM2	797	10
0163897L24	0163897L618	0163897LM1	0163897LM2	897	5
0163997L24	0163997L618	0163997LM1	0163997LM2	997	5
01631197L24	01631197L618	01631197LM1	01631197LM2	1197	5
-	-	01633000LM1	01633000LM2	3000	15 *

*Available only in M1 and M2 finishes. Three metre profiles are delivered according to the units of the original packaging and cannot be sold separately. / Disponible solo en los acabados M1 y M2. Las barras de tres metros se sirven según las cantidades del embalaje original y no se pueden servir por separado.

0168 **COMO** ZAMAK Designer: Viefe Studio

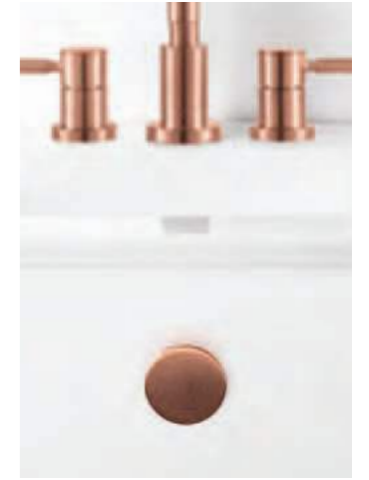
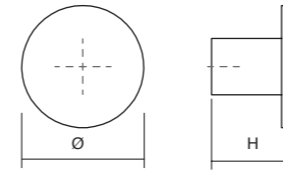

Z01 Polished chrome Cromo brillo	Z03 Polished titanium black Titanio negro brillo	Z06 Polished copper Cobre brillo	Z07 Polished brass Latón brillo	Z11 Matt chrome Cromo mate	Z23 Brushed nickel Níquel cepillado	Z26 Brushed copper Cobre cepillado	Z28 Brushed gold Oro cepillado	ZM1 Matt white Blanco mate	ZM2 Matt black Negro mate	Ø	H	⊞	
0168026Z01	0168026Z03	0168026Z06	0168026Z07	0168026Z11	0168026Z23	0168026Z26	0168026Z28	0168026ZM1	0168026ZM2	26	18	1	25
0168041Z01	0168041Z03	0168041Z06	0168041Z07	0168041Z11	0168041Z23	0168041Z26	0168041Z28	0168041ZM1	0168041ZM2	41	25	1	25

0497 **DIABOLO** ALUMINIUM Designer: Frank Person

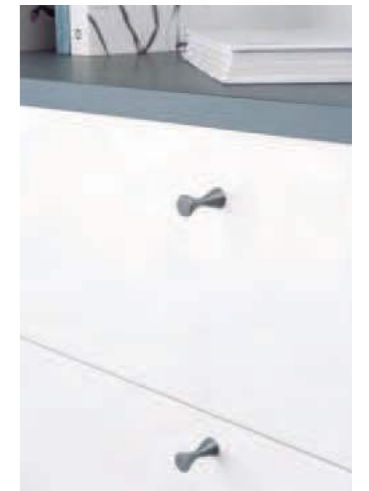
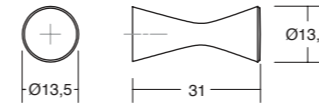

L24 Stainless steel look Inox look	L291 Brushed brass Latón cepillado	L30 Brushed black Negro cepillado	L31 Brushed grey Gris cepillado	⊞	⊞
0497014L24	0497014L291	0497014L30	0497014L31	1	25

0499 **ROUND** ALUMINIUM Designer: Balutto Associati

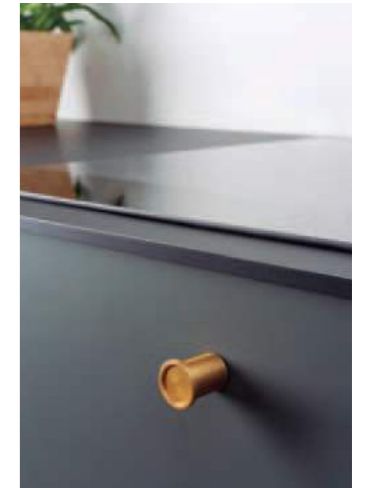
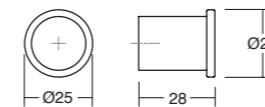

L24 Stainless steel look Inox look	L291 Brushed brass Latón cepillado	L30 Brushed black Negro cepillado	⊞	⊞
0499025L24	0499025L291	0499025L30	1	25

0518 **WAY** ALUMINIUM Designer: Viefe Studio

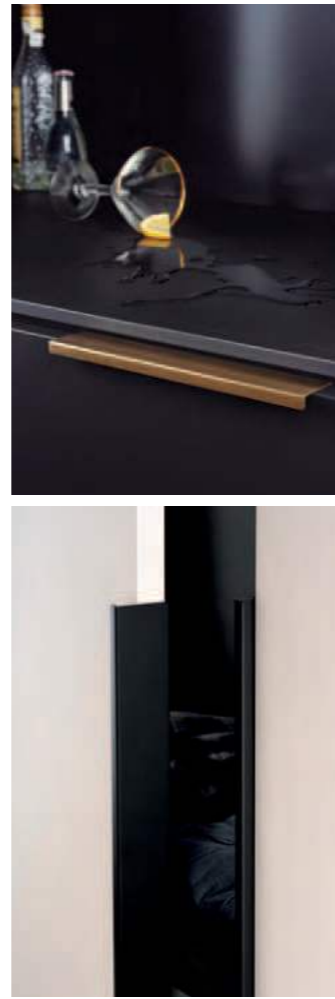
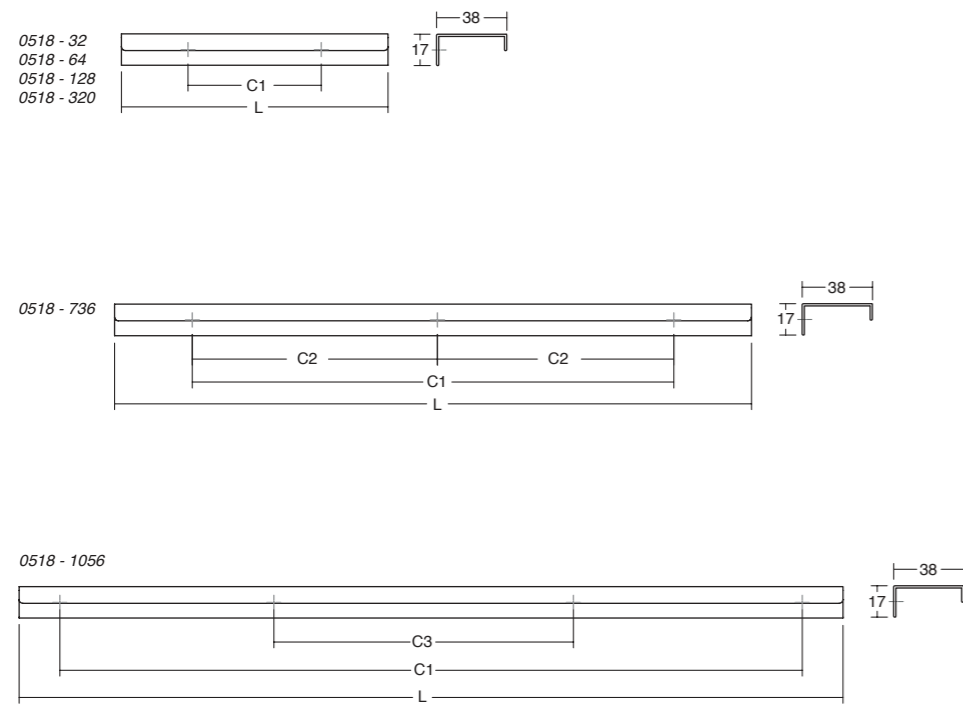

L04	L09	L24	L29	LM1	C1	C2	C3	L	↓	☐
Anodized matt Anodizado mate	Matt black Negro mate	Stainless steel look Inox look	Brushed dark brass Latón oscuro cepillado	Matt White Blanco mate						
0518032L04	0518032L09	0518032L24	0518032L29	0518032LM1	32	-	-	50	2	25
0518064L04	0518064L09	0518064L24	0518064L29	0518064LM1	64	-	-	100	2	25
0518128L04	0518128L09	0518128L24	0518128L29	0518128LM1	128	-	-	200	2	25
0518320L04	0518320L09	0518320L24	0518320L29	0518320LM1	320	-	-	400	2	25
0518736L04	0518736L09	0518736L24	0518736L29	0518736LM1	736	368	-	800	3	25
05181056L04	05181056L09	05181056L24	05181056L29	05181056LM1	1056	-	352	1100	4	15

0489 **BOL** ZAMAK / WOOD Designer: Balutto Associati

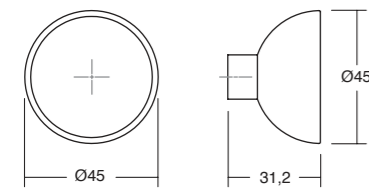

NM222 (ZM2+W22)	NM223 (ZM2+W23)	NM2M1 (ZM2+WM1)	↓	☐
Matt black + Sapelli Negro mate + Sapelli	Matt black + Beech Negro mate + Haya	Matt black + Matt white lacquered Negro mate + Lacado blanco mate		
0489045NM222	0489045NM223	0489045NM2M1	1	25

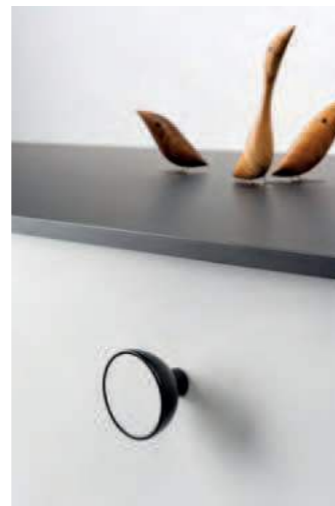

0511 **RAIL** ALUMINIUM Designer: Teruel & Paré

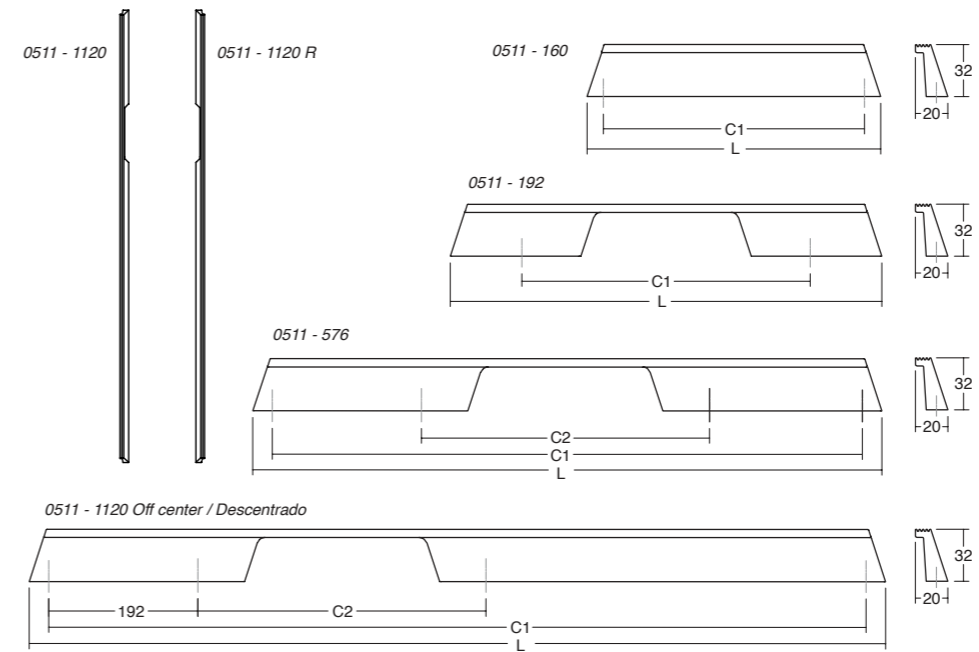

L24	L30	L618	C1	C2	L	↓	☐
Stainless steel look Inox look	Brushed black Negro cepillado	Brushed brass cava Latón cava cepillado					
0511160L24	0511160L30	0511160L618	160	-	180	2	25
0511192L24	0511192L30	0511192L618	192	-	280	2	25
0511576L24	0511576L30	0511576L618	576	192	600	4	15
05111120L24*	05111120L30*	05111120L618*	1120	192	1150	4	15 Off-center / Descentrado
05111120L24R*	05111120L30R*	05111120L618R*	1120	192	1150	4	15 Off-center / Descentrado

* The two 1150mm are symmetrical and one is left and the other right / Los dos de 1150mm son simétricos y uno es izquierda y el otro derecha



0056 **U** ZAMAK Designer: Viefe Studio

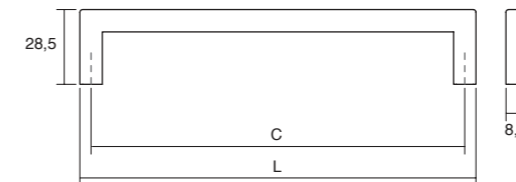

Z01	Z11	Z23	Z26	Z27	Z31	ZM1	ZM2	C	L	↓	☐
Polished chrome Cromo brillo	Matt chrome Cromo mate	Brushed nickel Níquel cepillado	Brushed copper Cobre cepillado	Brushed brass Latón cepillado	Brushed grey Gris cepillado	Matt white Blanco mate	Matt black Negro mate				
0056128Z01	0056128Z11	0056128Z23	0056128Z26	0056128Z27	0056128Z31	0056128ZM1	0056128ZM2	128	136,5	2	25
0056160Z01	0056160Z11	0056160Z23	0056160Z26	0056160Z27	0056160Z31	0056160ZM1	0056160ZM2	160	168,5	2	25
0056192Z01	0056192Z11	0056192Z23	0056192Z26	0056192Z27	0056192Z31	0056192ZM1	0056192ZM2	192	200,5	2	25
0056320Z01	0056320Z11	0056320Z23	0056320Z26	0056320Z27	0056320Z31	0056320ZM1	0056320ZM2	320	328,5	2	25
0056492Z01	0056492Z11	0056492Z23	0056492Z26	0056492Z27	0056492Z31	0056492ZM1	0056492ZM2	492	500,5	2	25



0507 **OBLONG** LEATHER / ZAMAK Designer: Frank Person

0507 - 160

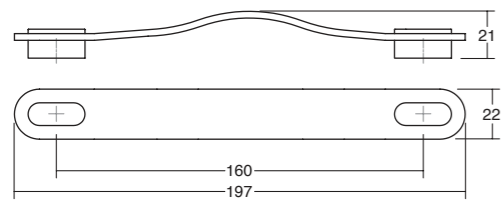

0507 - 070

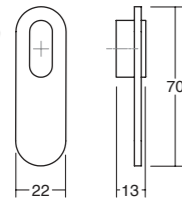

	P26 Beige / Beige	P36 Brown / Marrón	P99 Black / Negro	↓	📦
Z01 Polished chrome/ Cromo brillo	0507070P2601	0507070P3601	0507070P9901	1	25
Z01 Polished chrome/ Cromo brillo	0507160P2601	0507160P3601	0507160P9901	2	25
Z28 Brushed gold / Oro cepillado	0507070P2628	0507070P3628	0507070P9928	1	25
Z28 Brushed gold / Oro cepillado	0507160P2628	0507160P3628	0507160P9928	2	25
Z31 Brushed grey / Gris cepillado	0507070P2631	0507070P3631	0507070P9931	1	25
Z31 Brushed grey / Gris cepillado	0507160P2631	0507160P3631	0507160P9931	2	25
ZM1 Matt white / Blanco mate	0507070P26M1	-	-	1	25
ZM1 Matt white / Blanco mate	0507160P26M1	-	-	2	25
ZM2 Matt black / Negro mate	0507070P26M2	0507070P36M2	0507070P99M2	1	25
ZM2 Matt black / Negro mate	0507160P26M2	0507160P36M2	0507160P99M2	2	25

0494 **LAND** ZAMAK Designer: Héctor Diego

0494 - 040

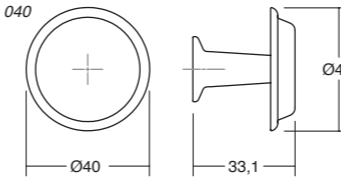

0494 - 064

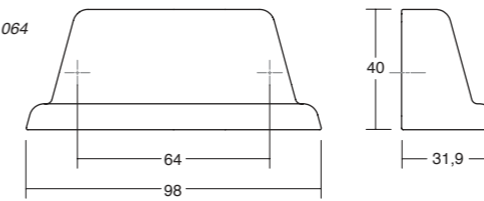

Z28 Brushed gold Oro cepillado	Z610 Pewter Peltre	Z614 Antique brass Latón antiguo	ZM2 Matt black Negro mate	↓	📦
0494040Z28	0494040Z610	0494040Z614	0494040ZM2	1	25
0494064Z28	0494064Z610	0494064Z614	0494064ZM2	2	25

0241 **ROMA** ZAMAK Designer: 2J Design

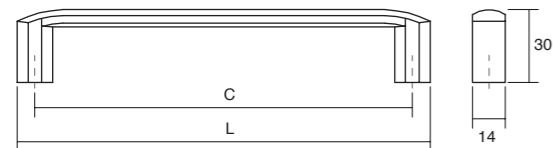

Z23 Brushed nickel Níquel cepillado	Z28 Brushed gold Oro cepillado	ZM2 Matt black Negro mate	C	L	↓	📦
0241160Z23	0241160Z28	0241160ZM2	160	175	2	25
0241192Z23	0241192Z28	0241192ZM2	192	207	2	25
0241320Z23	0241320Z28	0241320ZM2	320	335	2	25

0446 **ESTE** ZAMAK Designer: Balutto Associati

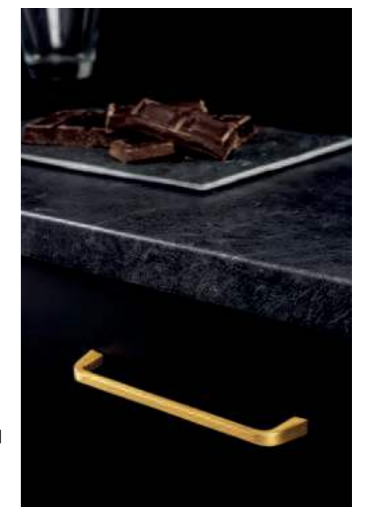
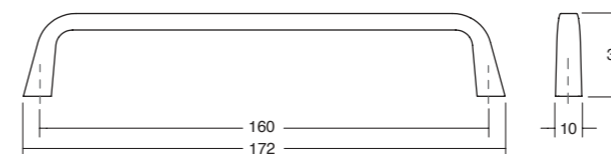

Z01 Polished chrome Cromo brillo	Z11 Matt chrome Cromo mate	Z23 Brushed nickel Níquel cepillado	Z26 Brushed copper Cobre cepillado	Z28 Brushed gold Oro cepillado	Z617 Graphite grey Gris grafito	ZM2 Matt black Negro mate	↓	📦
0446160Z01	0446160Z11	0446160Z23	0446160Z26	0446160Z28	0446160Z617	0446160ZM2	2	25

0506 **FIRM** ZAMAK Designer: Frank Person

0506 - 045

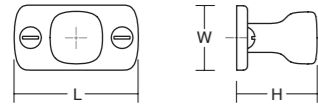

0506 - 093

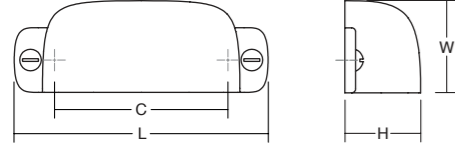

0506 - 064 / 096 / 160 / 320

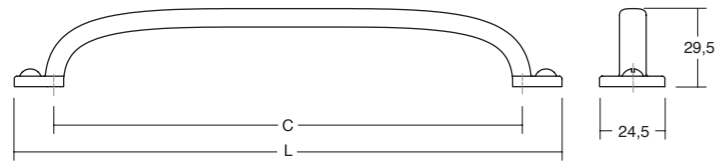

ZM22	C	L	W	H	↓	☐
Textured black Negro texturizado						
0506045ZM22	-	45,8	24	29,9	1	25
0506064ZM22	64	93,8	24,5	29,5	2	25
0506093ZM22	64	93,8	34	28	2	25
0506096ZM22	96	125,8	24,5	29,5	2	25
0506160ZM22	160	189,8	24,5	29,6	2	25
0506320ZM22	320	349,8	24,5	29,6	2	25



0516 **PENDANT** ZAMAK Designer: Frank Person

0516 - 040

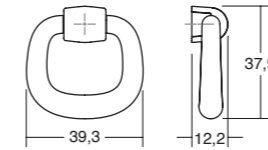

0516 - 128

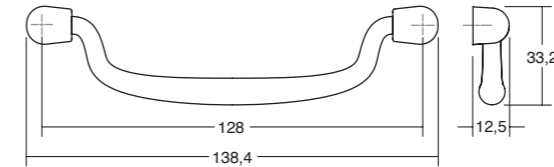

Z610	Z614	ZM2	↓	☐
Pewter Peltre	Antique brass Latón antiguo	Matt black Negro mate		
0516040Z610	0516040Z614	0516040ZM2	1	25
0516128Z610	0516128Z614	0516128ZM2	2	25

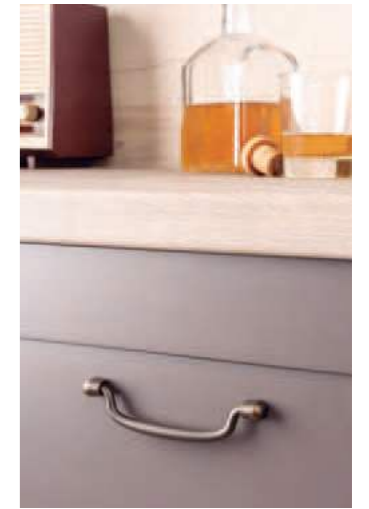

0459 **LINES** ZAMAK Designer: Teruel & Paré

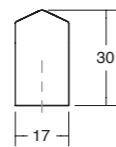
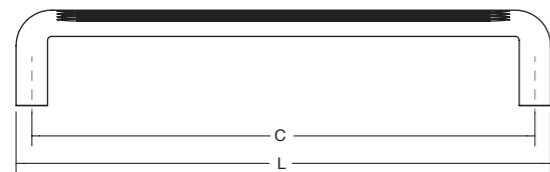

Z23	Z28	Z32	ZM2	C	L	↓	☐
Brushed Níquel Níquel cepillado	Brushed gold Oro cepillado	Brushed mole grey Gris topo cepillado	Matt black Negro mate				
0459160Z23	0459160Z28	0459160Z32	0459160ZM2	160	170	2	25
0459320Z23	0459320Z28	0459320Z32	0459320ZM2	320	330	2	25

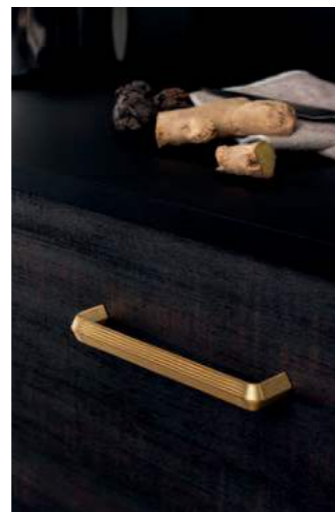

0094 **HIDE** ZAMAK Designer: Viefe Studio

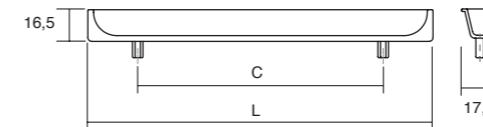

Z01	Z23	Z28	ZP1	ZM1	ZM2	C	L	↓	☐
Polished chrome Cromo brillo	Brushed nickel Níquel cepillado	Brushed gold Oro cepillado	Chrome look Cromo look	Matt white Blanco mate	Matt black Negro mate				
0094090Z01	0094090Z23	0094090Z28	-	0094090ZM1	0094090ZM2	64	90	2	25
0094180Z01	0094180Z23	0094180Z28	-	0094180ZM1	0094180ZM2	128	180	2	25
-	-	-	0094200ZP1	-	-	128	200	2	25

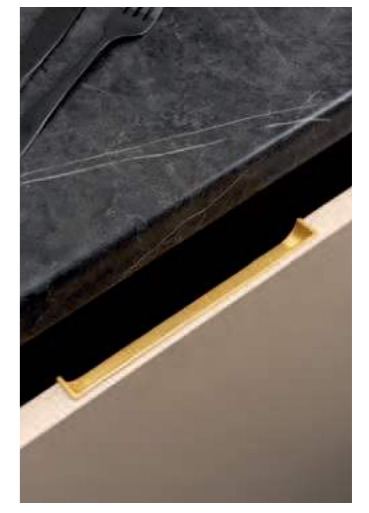

0486 **GRAF BIG** ALUMINIUM Designer: Viefe Studio

0486 - 038 / 050

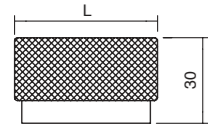

0486 - 192 / 320

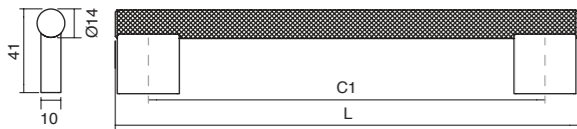

0486 - 1168

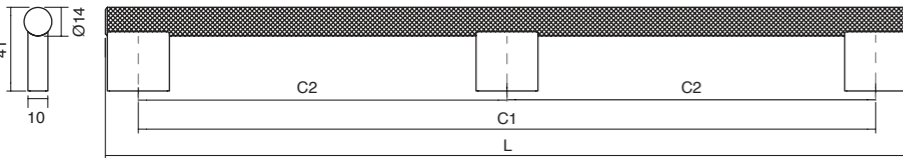

L24	L291	L30	C1	C2	L	↓	☐
Stainless steel look <i>Inox look</i>	Brushed brass <i>Latón cepillado</i>	Brushed black <i>Negro cepillado</i>	-	-	Ø38	1	25
0486038L24	0486038L291	0486038L30	-	-	Ø50	1	25
0486050L24	0486050L291	0486050L30	-	-	224	2	25
0486192L24	0486192L291	0486192L30	192	-	352	2	25
0486320L24	0486320L291	0486320L30	320	-	1168	584	1200
04861168L24	04861168L291	04861168L30	1168	584	1200	3	10



0430 **GRAF MINI** ALUMINIUM Designer: Viefe Studio

0430 - 160 / 256

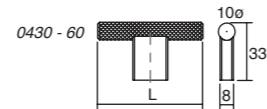
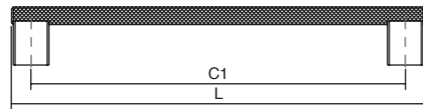

Includes non-twisting tip
Incluye punta anti-giro

0430 - 1178

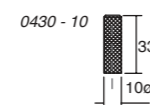
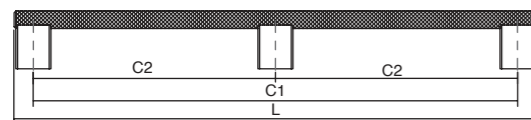

L24	L291	L30	C1	C2	L	↓	☐
Stainless steel look <i>Inox look</i>	Brushed brass <i>Latón cepillado</i>	Brushed black <i>Negro cepillado</i>	-	-	10	1	25
0430010L24	0430010L291	0430010L30	-	-	60	1	25
0430060L24	0430060L291	0430060L30	-	-	182	2	25
0430160L24	0430160L291	0430160L30	160	-	278	2	25
0430256L24	0430256L291	0430256L30	256	-	1178	589	1200
04301178L24	04301178L291	04301178L30	1178	589	1200	3	10



0109 **GRAF** ALUMINIUM Designer: Viefe Studio

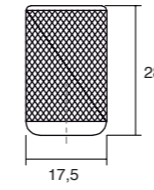

L01	L04	L24	L27	L291	LM2	↓	☐
Polished chrome <i>Cromo brillo</i>	Anodized matt <i>Anodizado mate</i>	Stain. steel look <i>Inox look</i>	Brushed brass <i>Latón cepillado</i>	Brushed brass <i>Latón cepillado</i>	Matt black <i>Negro mate</i>	1	25
0109017L01	0109017L04	0109017L24	0109017L27	0109017L291	0109017LM2	1	25



0447 **BELLA** ZAMAK Designer: Balutto Associati

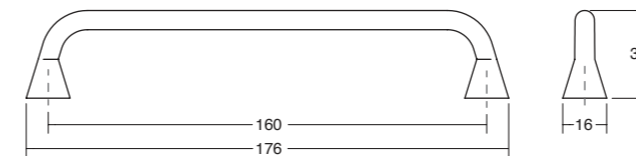

Z26	Z28	Z617	ZM2	↓	☐
Brushed copper <i>Cobre cepillado</i>	Brushed gold <i>Oro cepillado</i>	Graphite grey <i>Gris grafito</i>	Matt black <i>Negro mate</i>	2	25
0447160Z26	0447160Z28	0447160Z617	0447160ZM2	2	25



0451 **FELTRE** ZAMAK Designer: Balutto Associati

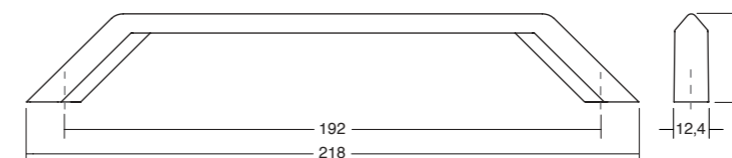

Z23	Z617	ZM2	↓	☐
Brushed nickel <i>Níquel cepillado</i>	Graphite grey <i>Gris grafito</i>	Matt black <i>Negro mate</i>	2	25
0451192Z23	0451192Z617	0451192ZM2	2	25



0449 **HEXXA** ALUMINIUM/ZAMAK Designer: Alexis Vivet

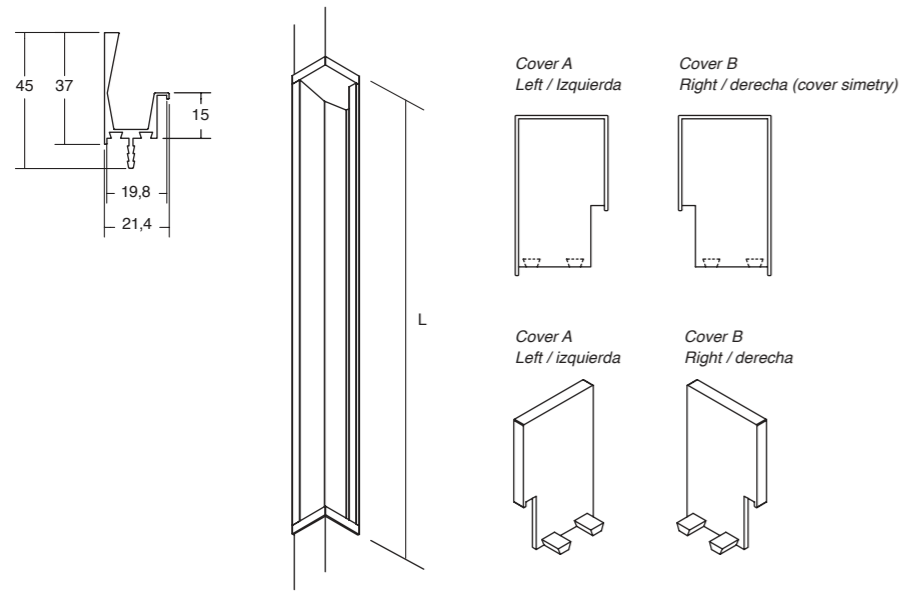

LM1	LM2	LM23	LM41	L	↓	☐
Matt white Blanco mate	Matt black Negro mate	Metallic grey Gris metal	Metallic brown Marrón metal			
0449200LM1	0449200LM2	0449200LM23	0449200LM41	200	25	ALUMINIUM
0449350LM1	0449350LM2	0449350LM23	0449350LM41	350	25	ALUMINIUM
04491100LM1	04491100LM2	04491100LM23	04491100LM41	1100	15	ALUMINIUM
04493000LM1	04493000LM2	04493000LM23	04493000LM41	3000	10*	ALUMINIUM
0449035ZM1A	0449035ZM2A	0449035ZM23A	0449035ZM41A	-	25	ZAMAK
0449035ZM1B	0449035ZM2B	0449035ZM23B	0449035ZM41B	-	25	ZAMAK

* Three metre profiles are delivered according to the units of the original packaging and cannot be sold separately.
Las barras de tres metros se sirven según las cantidades del embalaje original y no se pueden servir por separado.

0119 **WAVE** ZAMAK Designer: Viefte Studio

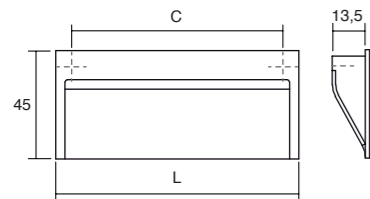

Z23	ZM2	C	L	↓	☐
Brushed nickel Níquel cepillado	Matt black Negro mate				
0119032Z23	0119032ZM2	32	45	2	25
0119160Z23	0119160ZM2	160	173	2	25

0105 **NEST** ZAMAK Designer: Viefte Studio

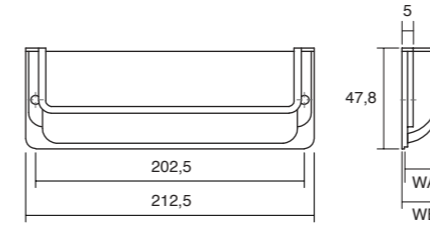

Z23	ZM2	WA	WB	↓	☐	Door
Brushed nickel Níquel cepillado	Matt black Negro mate					Puerta
0105186Z23ST	0105186ZM2ST	18,6	21,3	2	25	19
0105206Z23ST	-	20,6	23,3	2	25	20,5

0235 **CLOS** ZAMAK Designer: Viefte Studio

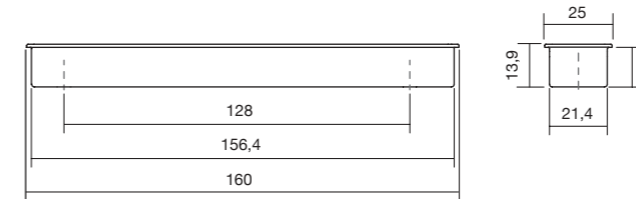

ZM1	ZM2	Z01	Z23	↓	☐
Matt white Blanco mate	Matt black Negro mate	Polished chrome Cromo brillo	Brushed nickel Níquel cepillado		
0235128ZM1	0235128ZM2	0235128Z01	0235128Z23	2	25

0366 **CUBIC** ZAMAK Designer: Viefte Studio

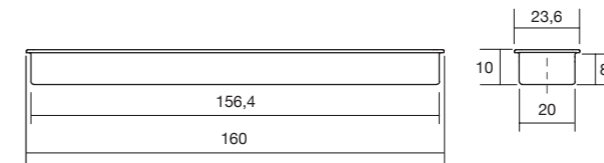

ZM1	ZM2	☐
Matt white Blanco mate	Matt black Negro mate	
0366160ZM1	0366160ZM2	25

0073 **TAP** ZAMAK Designer: Viefe Studio

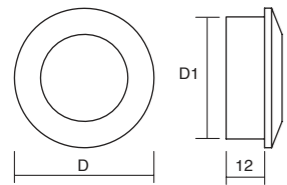

ZP1	ZM2	D	D1	↓	☐
Chrome look <i>Cromo look</i>	Matt black <i>Negro mate</i>				
0073040ZP1	0073040ZM2	40	35,5	25	
0073060ZP1	0073060ZM2	60	55,3	25	



0162 **KADO** ZAMAK Designer: Viefe Studio

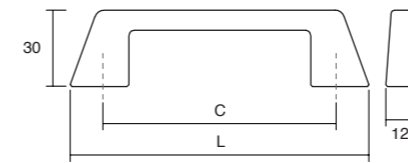

Z23	C	L	↓	☐
Brushed nickel <i>Níquel cepillado</i>				
0162160Z23	160	186	2	25
0162320Z23	320	346	2	25

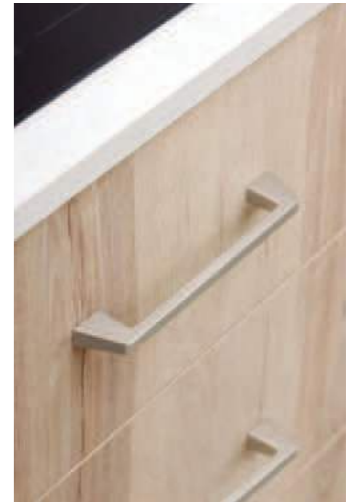

0301 **SENSE MINI** ALUMINIUM Designer: Viefe Studio

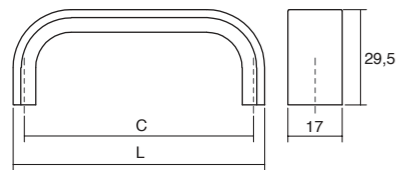

L01	L09	L24	L29	C	L	↓	☐
Polished chrome <i>Cromo brillo</i>	Matt black <i>Negro mate</i>	Stainless steel look <i>inox look</i>	Brushed dark brass <i>Latón oscuro cepillado</i>				
0301096L01	0301096L09	0301096L24	0301096L29	96	103	2	25
0301160L01	0301160L09	0301160L24	0301160L29	160	167	2	25
0301256L01	0301256L09	0301256L24	0301256L29	256	263	2	25



0373 **NICK** ZAMAK Designer: Alexis Vivet

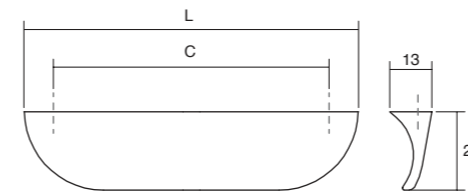

Z01	Z23	Z26	Z27	C	L	↓	☐
Polished chrome <i>Cromo brillo</i>	Brushed nickel <i>Níquel cepillado</i>	Brushed copper <i>Cobre cepillado</i>	Brushed brass <i>Latón cepillado</i>				
0373032Z01	0373032Z23	0373032Z26	0373032Z27	32	50	2	25
0373160Z01	0373160Z23	0373160Z26	0373160Z27	160	178	2	25



0195 **SENSE** ALUMINIUM Designer: Viefe Studio

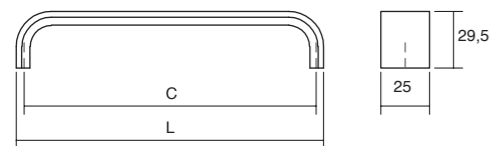

L01	L24	L30	C	L	↓	☐
Polished chrome <i>Cromo brillo</i>	Stainless steel look <i>Inox look</i>	Brushed black <i>Negro cepillado</i>				
0195128L01	0195128L24	0195128L30	128	135	2	25
0195192L01	0195192L24	0195192L30	192	199	2	25
0195320L01	0195320L24	0195320L30	320	327	2	25
0195480L01	0195480L24	0195480L30	480	487	2	25



0496 **BAU** ZAMAK Designer: Patricia Roig

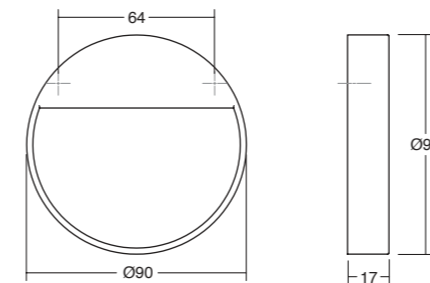

Z23	Z28	ZM2	↓	☐
Brushed nickel <i>Níquel cepillado</i>	Brushed gold <i>Oro cepillado</i>	Matt black <i>Negro mate</i>		
0496064Z23	0496064Z28	0496064ZM2	2	25

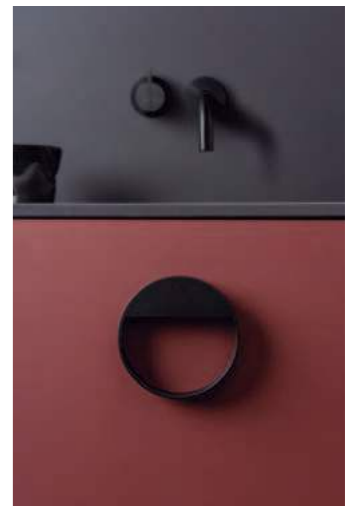

0077 **ANGLE** ALUMINIUM Designer: Viefe Studio

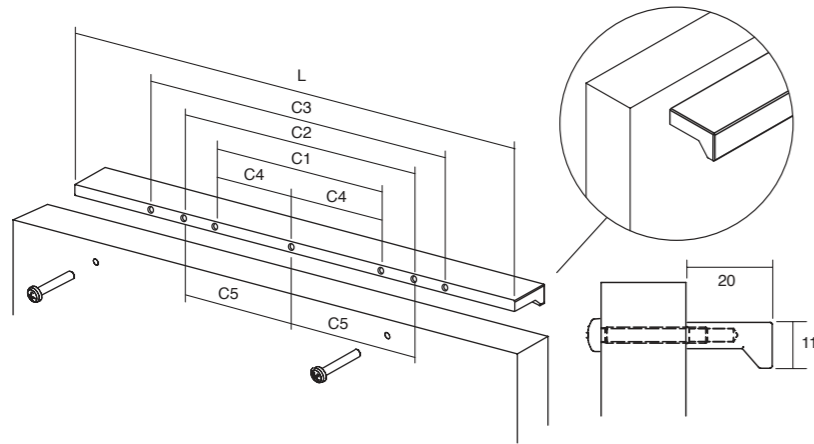

L01	L04	L24	L29	LM1	LM2	LM23	LM41	C1	C2	C3	C4	C5	L	↓	☐
Polish. chrome	Anodized matt	Stai. steel look	Brus. dark brass	Matt White	Matt black	Metallic grey	Metallic brown								
Cromo brillo	Anodizado mate	Inox look	Ltn osc. cepillado	Blanco mate	Negro mate	Gris metal	Marrón metal								
-	0077032L04	-	-	-	-	-	-	32	-	-	-	-	45	2	25
-	0077064L04	-	-	-	-	-	-	64	-	-	-	-	90	2	25
0077064L01	-	0077064L24	0077064L29	0077064LM1	0077064LM2	0077064LM23	0077064LM41	64	-	-	-	-	100	2	25
-	-	-	-	0077128LM1	0077128LM2	0077128LM23	0077128LM41	128	160	-	-	-	200	4	25
-	0077096L04	-	-	-	-	-	-	96	-	-	-	-	120	2	25
-	0077128L04	-	-	-	-	-	-	128	-	-	-	-	150	2	25
0077128L01	-	0077128L24	0077128L29	-	-	-	-	96	128	160	-	-	200	6	25
-	0077160L04	-	-	-	-	-	-	160	-	-	-	-	190	2	25
-	0077192L04	-	-	-	-	-	-	192	-	-	-	-	250	2	25
0077192L01	-	0077192L24	0077192L29	0077192LM1	0077192LM2	0077192LM23	0077192LM41	192	-	-	-	-	300	2	25
-	-	-	-	0077256LM1	0077256LM2	0077256LM23	0077256LM41	256	-	-	-	-	400	2	25
-	0077256L04	-	-	-	-	-	-	256	-	-	-	-	300	2	25
0077256L01	-	0077256L24	0077256L29	-	-	-	-	256	320	-	-	-	400	4	25
-	-	-	-	0077416LM1	0077416LM2	0077416LM23	0077416LM41	416	-	-	-	-	500	2	25
0077416L01	-	0077416L24	0077416L29	-	-	-	-	320	416	-	-	-	500	4	25
-	-	-	-	0077480LM1	0077480LM2	0077480LM23	0077480LM41	480	-	-	-	-	600	2	25
0077512L01	-	0077512L24	0077512L29	-	-	-	-	480	512	-	-	256	600	5	25
0077640L01	-	0077640L24	0077640L29	0077640LM1	0077640LM2	0077640LM23	0077640LM41	640	-	-	320	-	900	3	25
-	-	-	-	00771440LM1	00771440LM2	00771440LM23	00771440LM41	480	1440	-	-	-	1480	4	10

0206 **ARCH** ZAMAK Designer: 2J Design

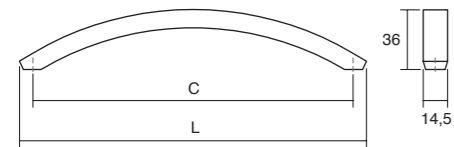

Z23	C	L	↓	☐
Brushed nickel				
Níquel cepillado				
0206192Z23	192	208,5	2	25
0206320Z23	320	338,5	2	25

0452 **BRAVE** ALUMINIUM Designer: Viefe Studio

LM1	LM2	LM23	LM41	C1	C2	L	↓	☐
Matt white	Matt black	Metallic grey	Metallic brown					
Blanco mate	Negro mate	Gris metal	Marrón metal					
0452128FM1	0452128FM2	0452128FM23	0452128FM41	128	-	160	2	25
0452192FM1	0452192FM2	0452192FM23	0452192FM41	192	-	240	2	25
0452320FM1	0452320FM2	0452320FM23	0452320FM41	320	-	400	2	25
0452480FM1	0452480FM2	0452480FM23	0452480FM41	192	480	600	4	25
0452992FM1	0452992FM2	0452992FM23	0452992FM41	192	992	1040	4	15
04521120FM1	04521120FM2	04521120FM23	04521120FM41	192	1120	1150	4	15

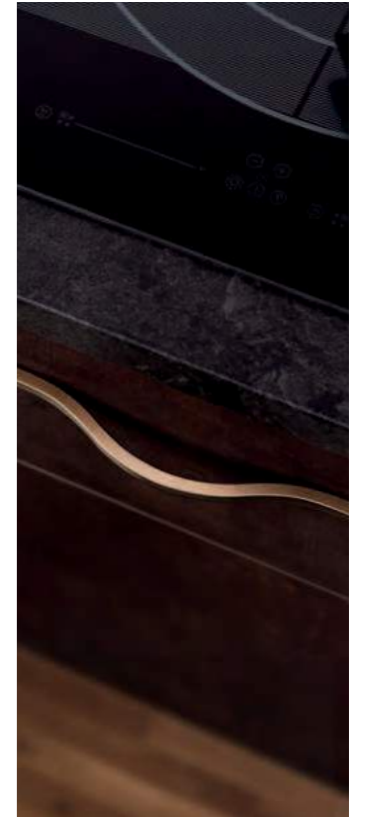
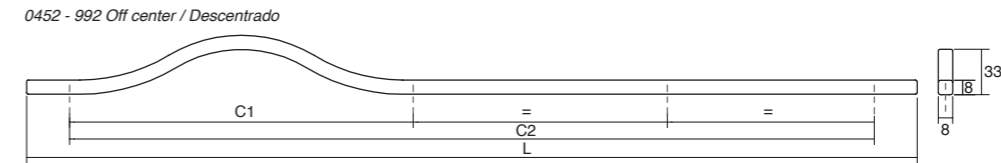
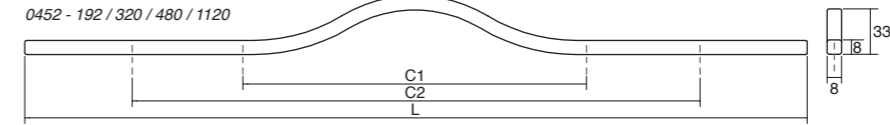
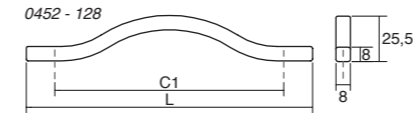

0322 **CUTT** ALUMINIUM Designer: Alexis Vivet

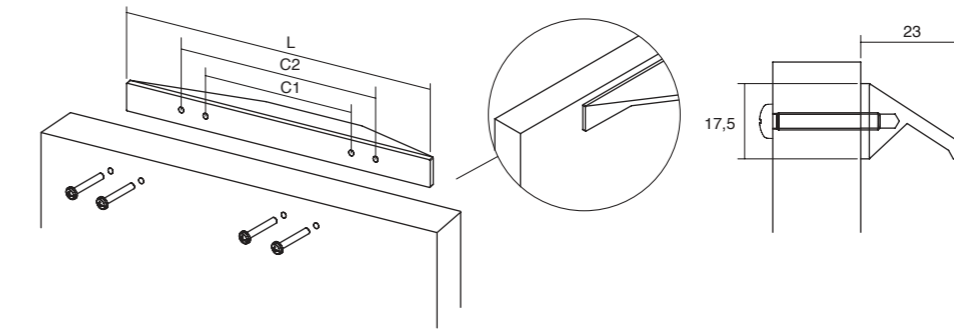

L01	L09	L24	C1	C2	L	↓	☐
Polished chrome	Matt black	Stainless steel look					
Cromo brillo	Negro mate	Inox look					
0322200L01	0322200L09	0322200L24	96	128	200	4	25
0322400L01	0322400L09	0322400L24	192	320	400	4	25
0322600L01	0322600L09	0322600L24	320	480	600	4	25
-	03221000L09	03221000L24	320	896	1000	4	15
-	03221500L09	03221500L24	480	1376	1500	4	10



0444 **PEAK** ALUMINIUM Designer: Viefe Studio

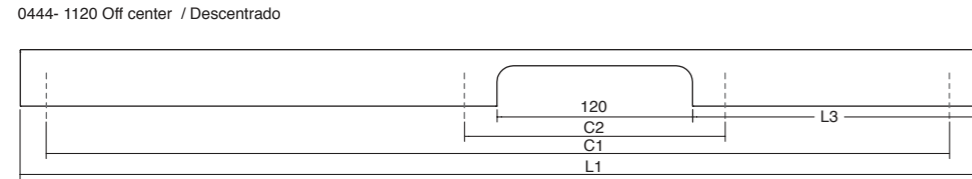
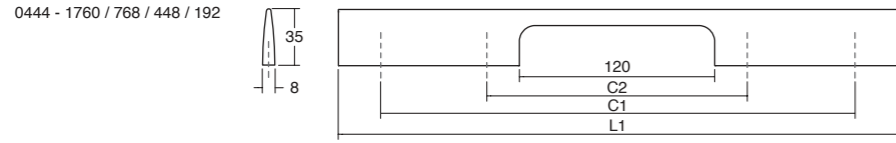
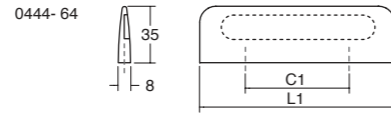

L24	L30	LM1	LM23	LM41	C1	C2	L1	L3	↓	☐
Stain. steel look Inox look	Brushed black Negro cepillado	Matt white Blanco mate	Metallic grey Gris metal	Metallic brown Marrón metal						
0444064L24	0444064L30	0444064LM1	0444064LM23	0444064LM41	64	-	120	-	2	25
0444192L24	0444192L30	0444192LM1	0444192LM23	0444192LM41	192	160	250	-	4	25
0444448L24	0444448L30	0444448LM1	0444448LM23	0444448LM41	448	160	500	-	4	25
0444768L24	0444768L30	0444768LM1	0444768LM23	0444768LM41	768	160	800	-	4	15
04441120L24	04441120L30	04441120LM1	04441120LM23	04441120LM41	1120	160	1150	190	4	15
04441760L24	04441760L30	04441760LM1	04441760LM23	04441760LM41	1760	160	1800	-	4	10



0372 **ONA** ALUMINIUM Designer: Teruel Paré

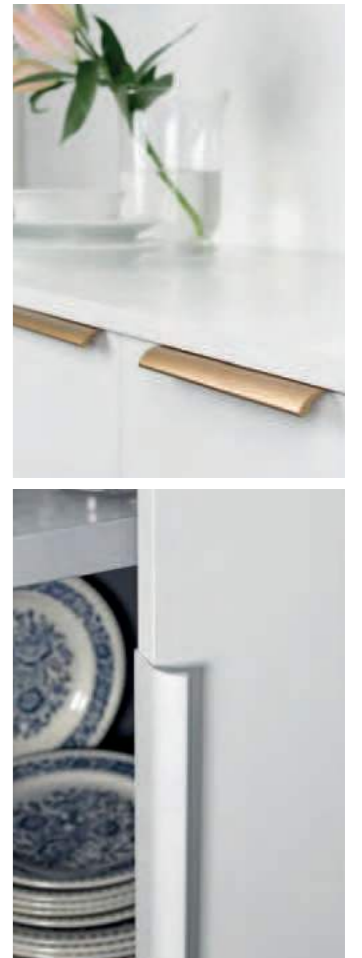
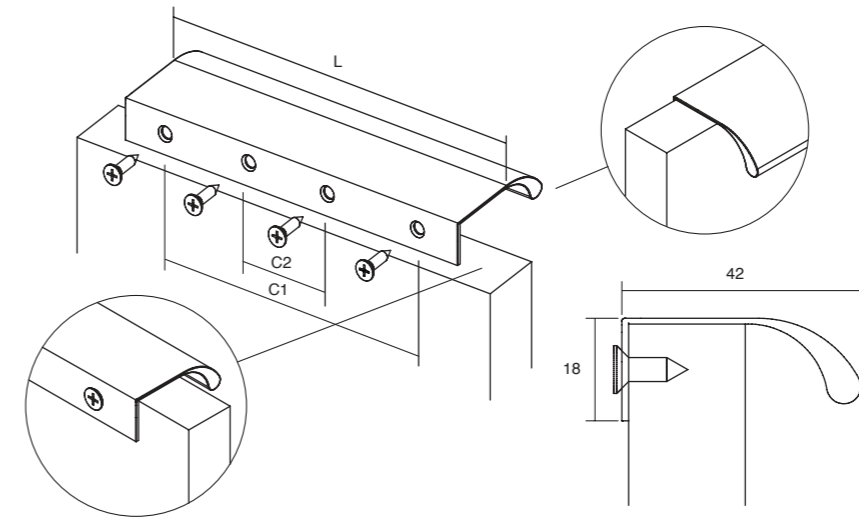

0375 **VANN** ALUMINIUM Designer: Alexis Vivet

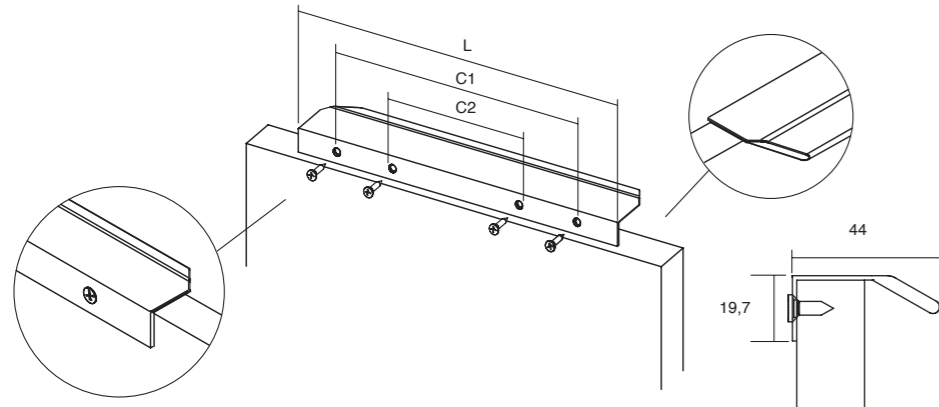

L02	L04	L09	L24	L29	NEW! L33	NEW! L619	NEW! LM1	C1	C2	L	↓	☐
Anodized bright Anodizado brillo	Anodized matt Anodizado mate	Matt black Negro mate	Stain steel look Inox look	Brushed dark brass Latón oscuro cepill.	Titanium black Negro titanio	Brushed bronze Bronce cepillado	Matt white Blanco mate					
0375064L02	0375064L04	0375064L09	0375064L24	0375064L29	0375064L33	0375064L619	0375064LM1	64	-	100	2	25
0375128L02	0375128L04	0375128L09	0375128L24	0375128L29	0375128L33	0375128L619	0375128LM1	128	-	200	2	25
0375256L02	0375256L04	0375256L09	0375256L24	0375256L29	0375256L33	0375256L619	0375256LM1	256	-	350	2	25
-	03751120L04	03751120L09	03751120L24	03751120L29	03751120L33	03751120L619	03751120LM1	1120	384	1200	4	15

0053 **DINO** ZAMAK Designer: Viefe Studio

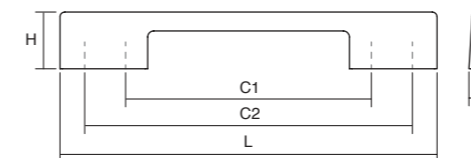

Z01	Z23	ZM1	ZM2	C1	C2	L	H	↓	☐
Polished chrome Cromo brillo	Brushed nickel Níquel cepillado	Matt white Blanco mate	Matt black Negro mate						
0053096Z01	0053096Z23	0053096ZM1	0053096ZM2	96	128	156	24	4	25
0053192Z01	0053192Z23	0053192ZM1	0053192ZM2	160	192	221	28	4	25
0053320Z01	0053320Z23	0053320ZM1	0053320ZM2	288	320	349	28	4	25

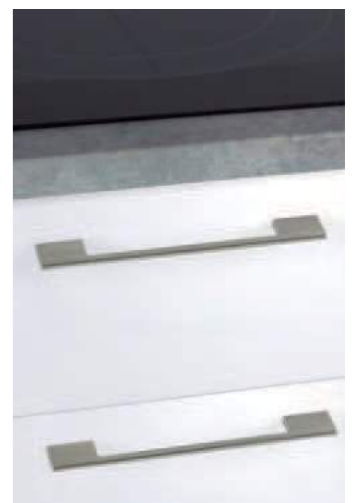

0117 **CURVE** ALUMINIUM Designer: Viefe Studio

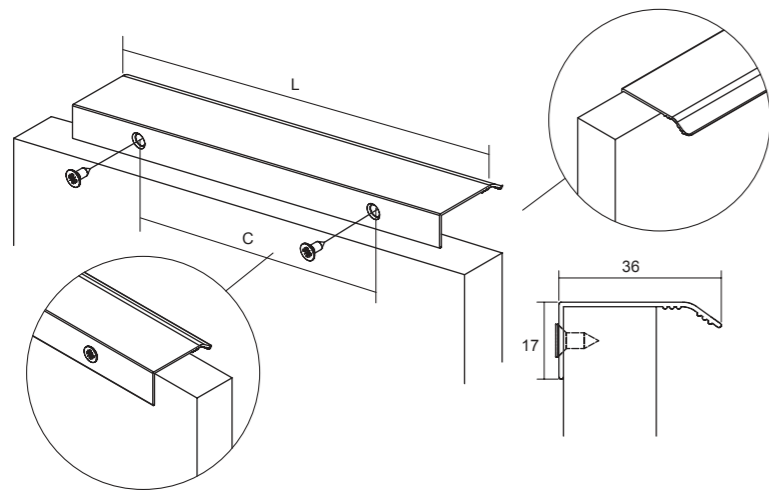

L04	L24	L31	LM1	LM2	C	L	↓	⊞
Anodized matt Anodizado mate	Stainless steel look Inox look	Brushed grey Gris cepillado	Matt white Blanco mate	Matt black Negro mate				
0117032L04	0117032L24	0117032L31	0117032LM1	0117032LM2	32	45	2	25
-	0117064L24	-	-	-	64	100	2	25
0117128L04	0117128L24	0117128L31	0117128LM1	0117128LM2	128	200	2	25
-	0117192L24	-	-	-	192	300	2	25
-	0117320L24	-	-	-	320	400	3	25
-	0117416L24	-	-	-	416	500	3	25

0434 **VECTOR** ALUMINIUM Designer: Viefe Studio

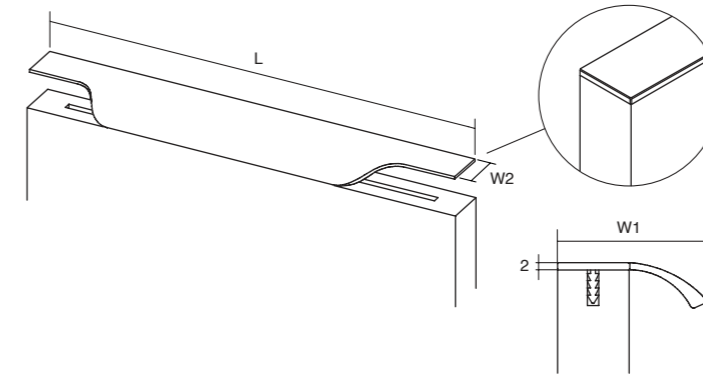

L24	L30	L31	L	W1	W2	⊞	Door Puerta
S. steel look Inox look	Brushed black Negro cepillado	Brushed grey Gris cepillado					
0434147L24	0434147L30	0434147L31	147	41	19.8	15	19
0434197L24	0434197L30	0434197L31	197	41	19.8	15	19
0434247L24	0434247L30	0434247L31	247	41	19.8	15	19
0434297L24	0434297L30	0434297L31	297	41	19.8	15	19
0434347L24	0434347L30	0434347L31	347	41	19.8	15	19
0434397L24	0434397L30	0434397L31	397	41	19.8	15	19
0434447L24	0434447L30	0434447L31	447	41	19.8	10	19
0434497L24	0434497L30	0434497L31	497	41	19.8	10	19
0434597L24	0434597L30	0434597L31	597	41	19.8	10	19
0434697L24	0434697L30	0434697L31	697	41	19.8	10	19
0434797L24	0434797L30	0434797L31	797	41	19.8	10	19
0434897L24	0434897L30	0434897L31	897	41	19.8	5	19
0434997L24	0434997L30	0434997L31	997	41	19.8	5	19
04341197L24	04341197L30	04341197L31	1197	41	19.8	5	19

0139 / 0140 **LINEAR** ALUMINIUM Designer: Viefe Studio

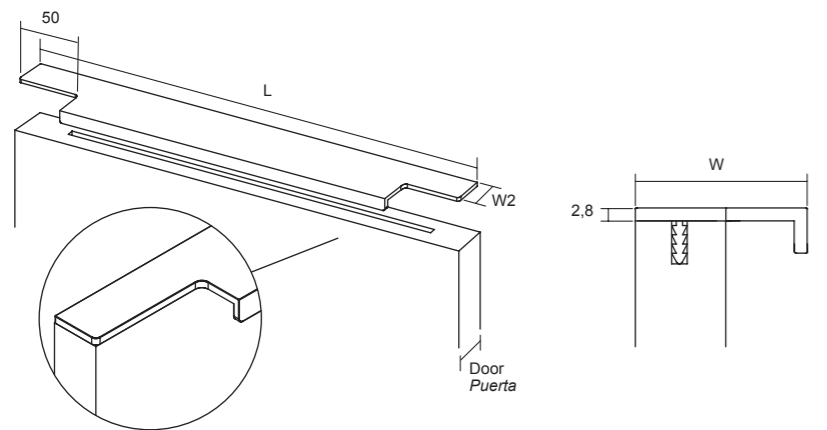

L24	L30	L	W (d19)	W2	⊞	Door Puerta
Stain. steel look Inox look	Brushed black Negro cepillado					
0139147L24	0139147L30	147	37	19,8	15	19mm
0139197L24	0139197L30	197	37	19,8	15	19mm
0139247L24	0139247L30	247	37	19,8	15	19mm
0139297L24	0139297L30	297	37	19,8	15	19mm
0139347L24	0139347L30	347	37	19,8	15	19mm
0139397L24	0139397L30	397	37	19,8	15	19mm
0139447L24	0139447L30	447	37	19,8	10	19mm
0139497L24	0139497L30	497	37	19,8	10	19mm
0139597L24	0139597L30	597	37	19,8	10	19mm
0139697L24	0139697L30	697	37	19,8	10	19mm
0139797L24	0139797L30	797	37	19,8	10	19mm
0139897L24	0139897L30	897	37	19,8	5	19mm
0139997L24	0139997L30	997	37	19,8	5	19mm
01391197L24	01391197L30	1197	37	19,8	5	19mm

L24	L30	L	W (d20,5)	W2	⊞	Door Puerta
Stain. steel look Inox look	Brushed black Negro cepillado					
0140147L24	0140147L30	147	38,5	21	15	20,5mm
0140197L24	0140197L30	197	38,5	21	15	20,5mm
0140247L24	0140247L30	247	38,5	21	15	20,5mm
0140297L24	0140297L30	297	38,5	21	15	20,5mm
0140347L24	0140347L30	347	38,5	21	15	20,5mm
0140397L24	0140397L30	397	38,5	21	15	20,5mm
0140447L24	0140447L30	447	38,5	21	10	20,5mm
0140497L24	0140497L30	497	38,5	21	10	20,5mm
0140597L24	0140597L30	597	38,5	21	10	20,5mm
0140697L24	0140697L30	697	38,5	21	10	20,5mm
0140797L24	0140797L30	797	38,5	21	10	20,5mm
0140897L24	0140897L30	897	38,5	21	5	20,5mm
0140997L24	0140997L30	997	38,5	21	5	20,5mm
01401197L24	01401197L30	1197	38,5	21	5	20,5mm

0254/0255 **NOMA** ALUMINIUM Designer: 2J Design

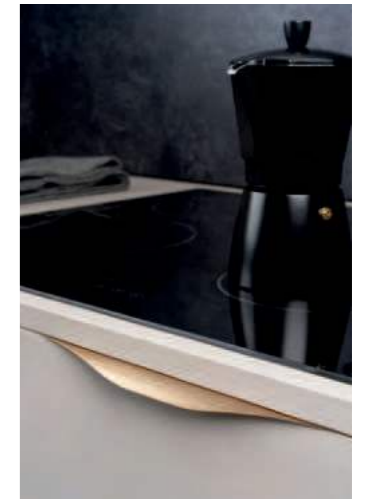
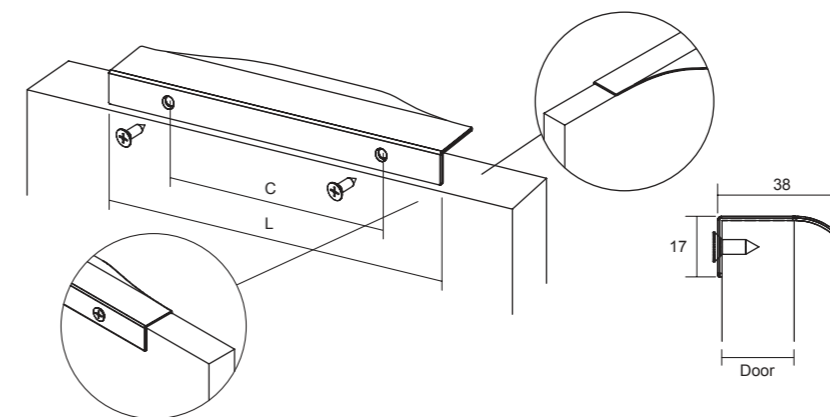

L02	L24	L30	L613	L618	C	L	↓	⊞	Door Puerta
Anodized bright Anodizado brillo	Stainless steel look Inox look	Brushed black Negro cepillado	Antique bronze Bronce antiguo	Brushed brass cava Latón cava cepillado					
0254128L02	0254128L24	0254128L30	0254128L613	0254128L618	128	200	2	25	19
0254256L02	0254256L24	0254256L30	0254256L613	0254256L618	256	350	2	25	19
-	0255128L24	-	-	-	128	200	2	25	22
-	0255256L24	-	-	-	256	350	2	25	22

0380 **STEEP** ALUMINIUM Designer: Viefe Studio

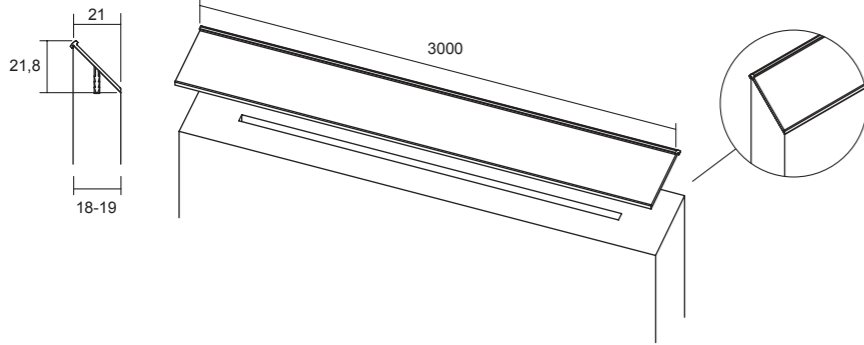

L02 Anodized bright Anodizado brillo	L24 Stainless steel look Inox look	LM2 Matt black Negro mate	15 *
03803000L02	03803000L24	03803000LM2	

* Three metre profiles are delivered according to the units of the original packaging and cannot be sold separately.
Las barras de tres metros se sirven según las cantidades del embalaje original y no se pueden servir por separado.

0343 **GRADA** ALUMINIUM Designer: Viefe Studio

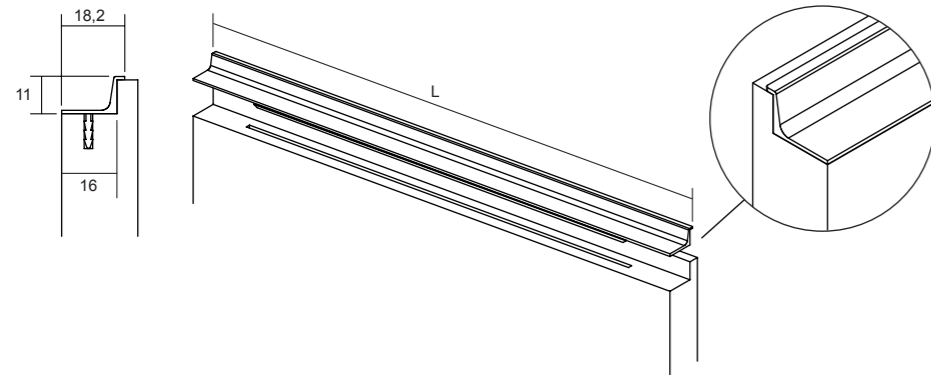

L02	L04	L24	LM1	LM2	L	15
Anodized bright Anodizado brillo	Anodized matt Anodizado mate	Stainless steel look Inox look	Matt white Blanco mate	Matt black Negro mate		
-	0343147L04	0343147L24	0343147LM1	0343147LM2	147	15
-	0343197L04	0343197L24	0343197LM1	0343197LM2	197	15
-	0343247L04	0343247L24	0343247LM1	0343247LM2	247	15
-	0343297L04	0343297L24	0343297LM1	0343297LM2	297	15
-	0343347L04	0343347L24	0343347LM1	0343347LM2	347	15
-	0343397L04	0343397L24	0343397LM1	0343397LM2	397	15
-	0343447L04	0343447L24	0343447LM1	0343447LM2	447	10
-	0343497L04	0343497L24	0343497LM1	0343497LM2	497	10
-	0343597L04	0343597L24	0343597LM1	0343597LM2	597	10
-	0343697L04	0343697L24	0343697LM1	0343697LM2	697	10
-	0343797L04	0343797L24	0343797LM1	0343797LM2	797	10
-	0343897L04	0343897L24	0343897LM1	0343897LM2	897	5
-	0343997L04	0343997L24	0343997LM1	0343997LM2	997	5
-	03431197L04	03431197L24	03431197LM1	03431197LM2	1197	5
03433000L02	03433000L04	03433000L24	03433000LM1	03433000LM2	3000	15*

* Three metre profiles are delivered according to the units of the original packaging and cannot be sold separately.
Las barras de tres metros se sirven según las cantidades del embalaje original y no se pueden servir por separado.

0219 **ARROW** ZAMAK Designer: 2J Design

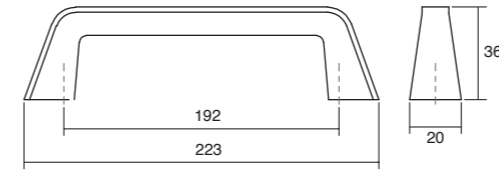

Z23 Brushed nickel Níquel cepillado	2	25
0219192Z23		

0410 **BUTTON** ZAMAK Designer: Alexis Vivet

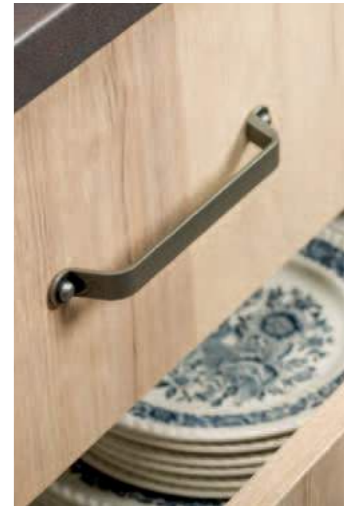
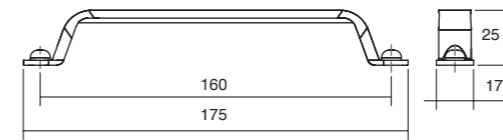

Z610 Pewter Peltre	Z614 Antique Brass Latón antiguo	ZM2 Matt black Negro mate	2	25
0410160Z610	0410160Z614	0410160ZM2		

0393 **DUKE** ZAMAK Designer: Viefe Studio

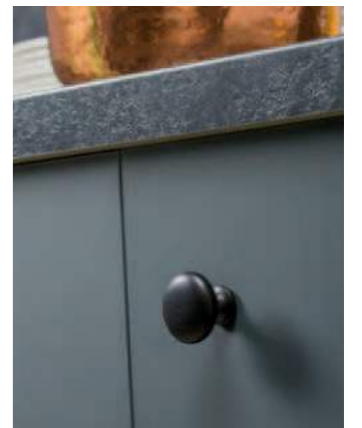
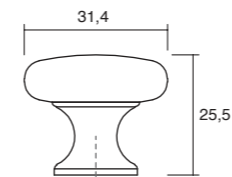

Z01 Pol. chrome Cromo brillo	Z23 Brushed nickel Níquel cepill.	Z26 Brushed copper Cobre cepillado	Z27 Brushed brass Latón cepillado	Z66 Antique copper Cobre antiguo	Z610 Pewter Peltre	Z612 Antique silver Plata antigua	Z614 Antique Brass Latón antiguo	ZM1 Matt white Blanco mate	ZM2 Matt black Negro mate	1	25
0393031Z01	0393031Z23	0393031Z26	0393031Z27	0393031Z66	0393031Z610	0393031Z612	0393031Z614	0393031ZM1	0393031ZM2		

0226 **REDO** ZAMAK Designer: 2J Design

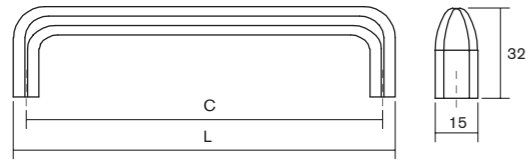

Z23	Z26	Z610	Z614	C	L	↓	☐
Brushed nickel	Brushed copper	Pewter	Antique Brass				
<i>Níquel cepillado</i>	<i>Cobre cepillado</i>	<i>Peltre</i>	<i>Latón antiguo</i>				
0226128Z23	0226128Z26	0226128Z610	0226128Z614	128	137	2	25
0226192Z23	0226192Z26	0226192Z610	0226192Z614	192	201	2	25

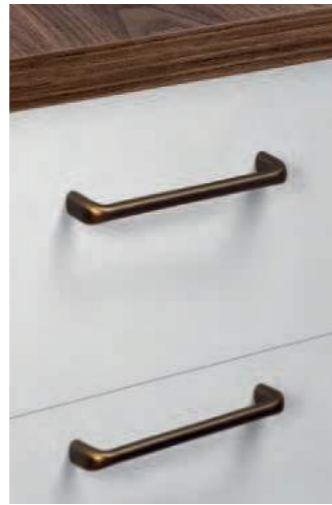

0390 **PETRA** ZAMAK Designer: Viefe Studio

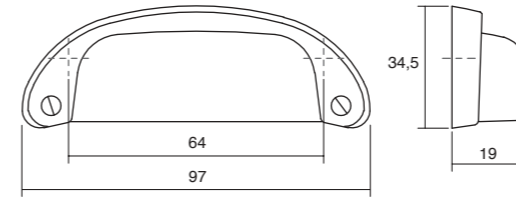

Z66	Z612	ZM2	↓	☐
Antique copper	Antique silver	Matt black		
<i>Cobre antiguo</i>	<i>Plata antigua</i>	<i>Negro mate</i>		
0390064Z66	0390064Z612	0390064ZM2	2	25



0405 **RAVIOLO** ZAMAK Designer: Balutto Associati

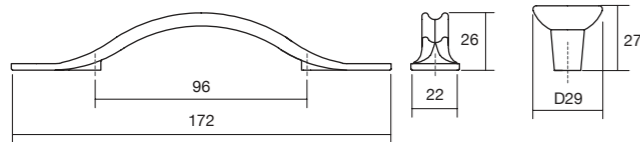

Z610	Z614	↓	☐
Pewter	Antique Brass		
<i>Peltre</i>	<i>Latón antiguo</i>		
0405029Z610	0405029Z614	1	25
0405096Z610	0405096Z614	2	25



0391 **AURA** ZAMAK Designer: Viefe Studio

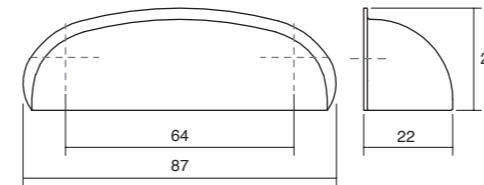

Z66	Z612	↓	☐
Antique copper	Antique silver		
<i>Cobre antiguo</i>	<i>Plata antigua</i>		
0391064Z66	0391064Z612	2	25



0312 **ARKO** ALUMINIUM Designer: Viefe Studio

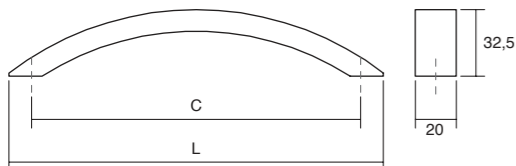

L24	C	L	↓	☐
Stain. steel look				
<i>Inox look</i>				
0312160L24	160	186	2	25
0312192L24	192	218	2	25
0312256L24	256	292	2	25



0392 **ORION** ZAMAK Designer: Viefe Studio

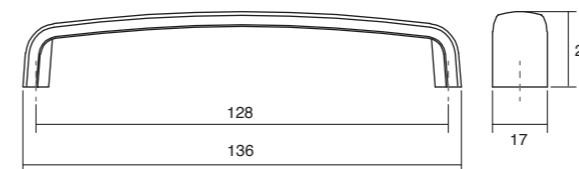

Z66	Z612	↓	☐
Antique copper	Antique silver		
<i>Cobre antiguo</i>	<i>Plata antigua</i>		
0392128Z66	0392128Z612	2	25



0404 **FLEXA** LEATHER + ZAMAK Designer: Balutto Associati

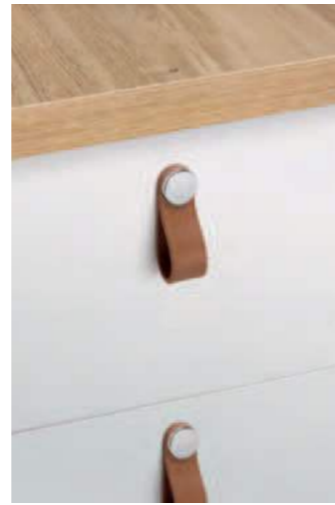
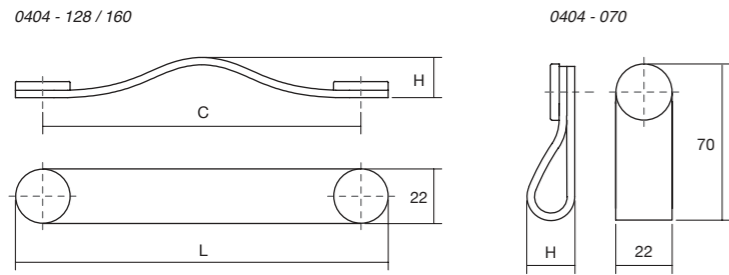

	P26 Beige / Beige	P36 Brown / Marrón	P99 Black / Negro	C	L	H	↓	☒
Z01 Polished chrome / Cromo brillo	0404070P2601	0404070P3601	0404070P9901	-	70	24	1	25
Z01 Polished chrome / Cromo brillo	0404128P2601	0404128P3601	0404128P9901	128	150	25	2	25
Z01 Polished chrome / Cromo brillo	0404160P2601	0404160P3601	0404160P9901	160	182	27	2	25
Z610 Pewter / Peltre	0404070P2610	0404070P3610	0404070P9910	-	70	24	1	25
Z610 Pewter / Peltre	0404128P2610	0404128P3610	0404128P9910	128	150	25	2	25
Z610 Pewter / Peltre	0404160P2610	0404160P3610	0404160P9910	160	182	27	2	25
ZM2 Black / Negro	0404070P26M2	0404070P36M2	0404070P99M2	-	70	24	1	25
ZM2 Black / Negro	0404128P26M2	0404128P36M2	0404128P99M2	128	150	25	2	25
ZM2 Black / Negro	0404160P26M2	0404160P36M2	0404160P99M2	160	182	27	2	25
Z27 Brass / Latón	0404070P2627	0404070P3627	0404070P9927	-	70	24	1	25
Z27 Brass / Latón	0404128P2627	0404128P3627	0404128P9927	128	150	25	2	25
Z27 Brass / Latón	0404160P2627	0404160P3627	0404160P9927	160	182	27	2	25

0340 **BARCCO** WOOD Designer: Alexis Vivet

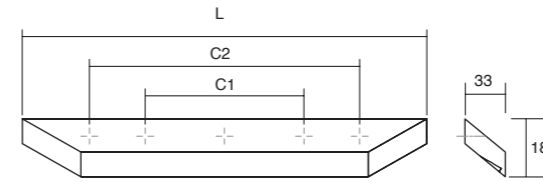

W18 Ash Fresno	W19 Walnut Nogal	W00 Beech raw Haya crudo	C1	C2	L	↓	☒
0340200W18	0340200W19	0340200W00	160	-	200	3	25
0340400W18	0340400W19	0340400W00	320	-	400	3	25
0340600W18	0340600W19	0340600W00	320	480	600	4	25



0165 **CALIN** WOOD Designer: Viefe Studio

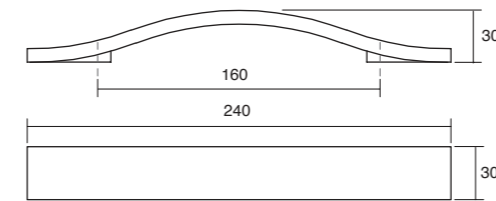

W00 Raw brushed Crudo cepillado	W02 White brushed Blanco cepillado	W08 Brown brushed Marrón cepillado	W09 Black brushed Negro cepillado	↓	☒
0165160W00	0165160W02	0165160W08	0165160W09	2	25



0239 **ARA W** ALUMINIUM + WOOD Designer: 2J Design

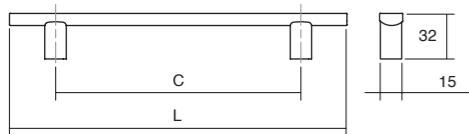

N2416 (L24+W16) Stainless steel look + Oak Inox look + Roble	N2417 (L24+W17) Stainless steel look + Walnut Inox look + Nogal	C	L	↓	☒
0239160N2416	0239160N2417	160	220	2	25
0239224N2416	0239224N2417	224	284	2	25



0166 **ECHO** WOOD Designer: Viefe Studio

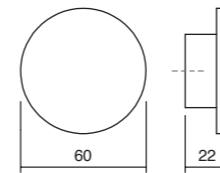

W00 Raw brushed Crudo cepillado	W02 White brushed Blanco cepillado	W08 Brown brushed Marrón cepillado	W09 Black brushed Negro cepillado	↓	☒
0166060W00	0166060W02	0166060W08	0166060W09	1	25



0243 **LOW ST** ZAMAK Designer: Viefe Studio

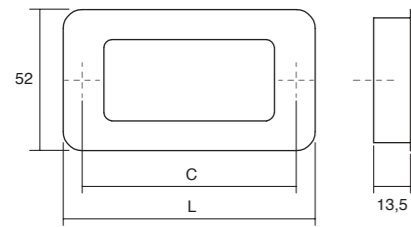

Z23
Brushed nickel
Níquel cepillado

	C	L	↓	☐
0243064Z23ST	64	78	2	25
0243192Z23ST	192	206	2	25

With backplate / Con placa posterior



0376 **BOXX** ZAMAK Designer: Alexis Vivet

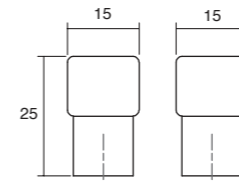

Z01 Polished chrome
Cromo brillo

Z11 Matt chrome
Cromo mate

Z23 Brushed nickel
Níquel cepillado

ZM2 Matt black
Negro mate

	C	L	↓	☐
0376012Z01			1	25
0376012Z11				
0376012Z23				
0376012ZM2				



0281 **FLAT** ZAMAK Designer: Oriol Barri

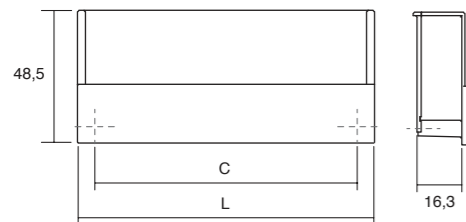

Z23
Brushed nickel
Níquel cepillado

	C	L	↓	☐
0281160Z23	160	174,8	2	25



0064 **KOMBI** STAINLESS STEEL Designer: Viefe Studio

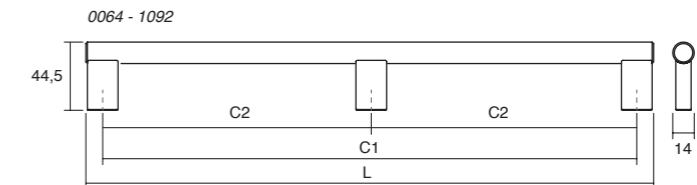
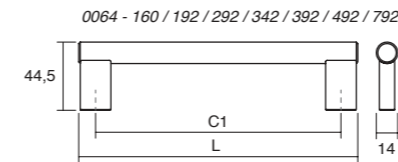

S25
Brushed stainless steel
Inox cepillado

	C1	C2	L	↓	☐
0064160S25	160	-	182	2	25
0064192S25	192	-	214	2	25
0064292S25	292	-	314	2	25
0064342S25	342	-	364	2	25
0064392S25	392	-	414	2	25
0064492S25	492	-	514	2	25
0064792S25	792	-	814	2	10
00641092S25	1092	546	1114	3	10



0091 **RASO** ZAMAK Designer: Viefe Studio

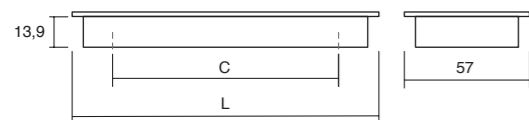

Z23
Brushed nickel
Níquel cepillado

	C	L	↓	☐
0091032Z23	32	70	2	25
0091108Z23	108	152,5	2	25



6005 **FONDA** ALUMINIUM Designer: Viefe Studio

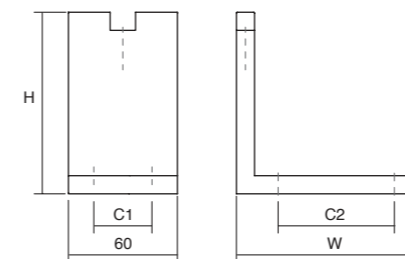

L01 Polished chrome
Cromo brillo

L24 Stainless steel look
Inox look

L29 Brushed dark brass
Latón oscuro cepillado

L30 Brushed black
Negro cepillado

	C1	C2	W	H	↓	☐
6005100L01	32	44	80	100	4	24
6005150L01	32	44	80	150	4	24
6005200L01	32	64	100	200	4	24



FINISHES FOR UNIQUE EXPERIENCES

EN |

Our finishes are more than just how they look and feel – they influence how we view the furniture in a room, the very atmosphere. Now, added to the iconic polished nickel, brushed black, titanium black and brushed brass cava is the new brushed bronze, which conveys a timeless sophistication perfect for trendy interiors.

ES |

Nuestros acabados proporcionan experiencias que van más allá del tacto, ya que influyen en la percepción de los muebles y de los ambientes. Ahora, los icónicos níquel brillo, negro cepillado, negro titanium y latón cava cepillado se enriquecen con la incorporación del nuevo bronce cepillado que transmite una sofisticación atemporal perfecta para interiorismos de tendencia.

CA |

Els nostres acabats proporcionen experiències que van més enllà del tacte, ja que influeixen a la percepció dels mobles i dels ambients. Ara, els icònics níquel brillant, negre raspallat, negre titanium i llautó cava raspallat s'enriqueixen amb la incorporació del nou bronze raspallat que transmet una sofisticació atemporal perfecta per a interiorismes de tendència.

L619

Brushed bronze
Bronce cepillado

FINISHES

ZAMAK

Glossy Brillante

-  **Z01**
Polished chrome
Cromo brillo
-  **Z03**
Polished titanium black
Titanio negro brillo
-  **Z05**
Polished nickel
Níquel brillo
-  **Z06**
Polished copper
Cobre brillo
-  **Z07**
Polished brass
Latón brillo

Grey Gris

-  **Z11**
Matt chrome
Cromo mate
-  **Z31**
Brushed grey
Gris cepillado
-  **Z32**
Brushed mole grey
Gris topo cepillado
-  **Z617**
Graphite grey
Gris grafito
-  **ZP1**
Chrome look
Look cromo

Brass Latón

-  **Z27**
Brushed brass
Latón cepillado
-  **Z28**
Brushed gold
Oro cepillado
-  **Z618**
Brushed brass cava
Latón cava cepillado

Black Negro

-  **ZM2**
Matt black
Negro mate
-  **Z33**
Titanium black
Negro titanio

Color Color

-  **ZM25**
Moss grey
Gris musgo
-  **ZM31**
Forest green
Verde forest
-  **ZM41**
Metallic brown
Marrón metal
-  **ZM43**
Mocca brown
Marrón mocca
-  **ZM72**
Volcano red
Rojo volcana

White Blanco

-  **ZM1**
Matt white
Blanco mate

Copper Cobre

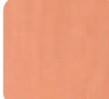
-  **Z26**
Brushed copper
Cobre cepillado

Inox look Look inox



-  **Z23**
Brushed nickel
Níquel cepillado

Vintage Vintage

-  **Z66**
Antique copper
Cobre antiguo
-  **Z610**
Pewter
Peltre
-  **Z612**
Antique silver
Plata antigua
-  **Z614**
Antique brass
Latón antiguo
-  **Z623**
Rustic brass
Latón rústico
-  **ZM22**
Textured black
Negro texturizado

ALUMINIUM

Glossy Brillante

-  **L01**
Polished chrome
Cromo brillo
-  **L02**
Anodized bright
Anodizado brillo
-  **L05**
Polished nickel
Níquel brillo

Grey Gris

-  **L04**
Anodized matt
Anodizado mate
-  **L31**
Brushed grey
Gris cepillado
-  **LM23**
Metallic grey
Gris metal

Brass Latón

-  **L29**
Brushed dark brass
Latón oscuro cepillado
-  **L291**
Brushed brass
Latón cepillado
-  **L618**
Brushed brass cava
Latón cava cepillado

Black Negro

-  **L09 / LM2**
Matt black
Negro mate
-  **L30**
Brushed black
Negro cepillado
-  **L33**
Titanium black
Negro titanio

White Blanco

-  **LM1**
Matt white
Blanco mate

Bronze Bronce

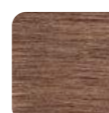
-  **L19**
Matt bronze
Bronce mate
-  **L619**
Brushed bronze
Bronce cepillado

Color Color

-  **LM41**
Metallic brown
Marrón metal
-  **LM25**
Moss grey
Gris musgo
-  **LM31**
Forest green
Verde forest
-  **LM43**
Mocca brown
Marrón mocca
-  **LM72**
Volcano red
Rojo volcana
-  **LM82**
Midnight blue
Azul midnight

Vintage Vintage

-  **L613**
Antique bronze
Bronce antiguo
-  **L623**
Rustic brass
Latón rústico

Textured Texturizado

-  **LMT1**
Textured matt white
Blanco mate texturizado
-  **LMT27**
Textured lava black
Negro lava texturizado
-  **LMT41**
Textured metallic brown
Marrón metal texturizado

Stainless steel look Look inox

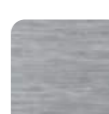
-  **L24**
Stainless steel look
Inox look

STAINLESS STEEL

-  **S25**
Brushed stainless steel
Inox cepillado

WOOD

-  **W00**
Raw brushed
Crudo cepillado
-  **W02**
White brushed
Blanco cepillado
-  **W08**
Brown brushed
Marrón cepillado
-  **W09**
Black brushed
Negro cepillado
-  **W16**
Oak
Roble
-  **W17**
Walnut
Nogal
-  **W18**
Ash
Fresno
-  **WM2**
Wood matt black lacquered
Madera lacada negra mate

LEATHER

-  **P26**
Beige
Beige
-  **P36**
Brown
Marrón
-  **P99**
Black
Negro

IMPORTANT NOTE:

The finishes that you see represented in this section are a digital simulation of the real finishes and in no way can they be used as a reference for physical comparisons. The aim of this index is to guide and inform the user about the finishes we work with. The finishes of all our models are defined exactly as is indicated in the catalogue and therefore are in no way characteristics that can be personalized.

NOTA IMPORTANTE:

Los acabados representados en esta sección son una simulación digital de los acabados reales y en ningún caso se pueden utilizar como referencia para comparativas físicas. Este índice se debe utilizar únicamente como orientación para conocer los acabados con los que trabaja Viefe. Todos los diseños de Viefe tienen sus acabados definidos tal como indica el catálogo y, por lo tanto, no es una característica personalizable en ningún caso.

NOTA IMPORTANT:

Els acabats representats en aquesta secció són una simulació digital dels acabats reals i en cap cas es poden utilitzar com a referència per a comparatives físiques. Aquest índex s'ha d'utilitzar únicament com a orientació per conèixer els acabats amb els que treballa Viefe. Tots els dissenys de Viefe tenen els seus acabats definits tal com indica el catàleg i per tant no és una característica personalitzable en cap cas.

INDEX

Number	Model	Product pag	Tech info pag
0077	ANGLE	184 - 185	340
0239	ARA W	282 - 283	350
0206	ARCH	290	340
0312	ARKO	291	348
0583	ARPA	158 - 159	324
0588	ARPA PLATE	156 - 157	323
0219	ARROW	287	347
0391	AURA	281	349
0340	BARCCO	284 - 285	351
0496	BAU	188 - 189	339
0673	BEAM NEW!	30 - 35	297
0447	BELLA	230 - 231	335
0590	BELT	120 - 123	314
0489	BOL	210 - 211	328
0376	BOXX	289	353
0452	BRAVE	250 - 251	341
0676	BROOKLYN NEW!	16 - 19	298
0677 / 0678 / 0679	BROOKLYN BIG NEW!	20 - 23	299
0410	BUTTON	270 - 271	347
0165	CALIN	286	351
0698	CANO NEW!	52 - 55	303
0700	CASEY NEW!	24 - 25	304
0701 / 0702 / 0703	CASEY BIG NEW!	26 - 29	304
0235	CLOS	240 - 241	337
0168	COMO	194 - 197	327
0538	CONIC wood	168 - 169	320
0538	CONIC zamak	170 - 171	321
0366	CUBIC	278	337
0117	CURVE	254 - 255	344
0322	CUTT	268 - 269	341
0497	DIABOLO	198 - 199	327
0053	DINO	264 - 265	343
0556	DIPO	178 - 179	321
0530	DISC wood	164 - 165	320
0530	DISC zamak	166 - 167	320
0393	DUKE	272 - 273	347
0658	DUO	110 - 111	311
0659 / 0668 / 0670	DUO BIG	112 - 113	311
0696	DROPP NEW!	62 - 63	302
0166	ECHO	287	351
0614	EQUIS	148 - 149	319
0446	ESTE	228 - 229	331
0591	ETO	136 - 139	316
0451	FELTRE	248 - 249	335
0506	FIRM	160 - 163	332
0610	FLAPP	130 - 131	316
0613	FLAPP WOOD	132 - 135	317
0281	FLAT	288	352
0404	FLEXA	214 - 215	350
0495	FLOID	186 - 187	325
0542	FOLD	172 - 173	323
6005	FONDA	292 - 293	353
0250 / 0251	FORMA	263	325
0627	FUSION	84 - 87	305
0343	GRADA	260 - 261	346
0109	GRAF	224 - 225	335
0486	GRAF BIG	220 - 221	334
0430	GRAF MINI	222 - 223	334
0695	HAKO NEW!	44 - 47	301
0705 / 0706 / 0707	HAKO BIG NEW!	48 - 51	302
0449	HEXXA	232 - 233	336
0094	HIDE	234 - 235	333
0686	HINOKI NEW!	36 - 37	300
0687	HINOKI BIG NEW!	38 - 39	301

0681	HINOKI WOOD NEW!	40 - 41	299
0682	HINOKI WOOD BIG NEW!	42 - 43	300
0127	JEY	190 - 193	326
0163	JEY2	192 - 193	326
0162	KADO	290	339
0064	KOMBI	278	353
0494	LAND	216 - 217	331
0635	LIDD	88 - 89	306
0139 / 0140	LINEAR	256 - 257	344
0459	LINES	226 - 227	332
0643	LINKK	92 - 95	307
0603	LIPP	100 - 101	308
0243 ST	LOW ST	288	352
0536	LUV	76 - 77	312
0699	LUV WOOD NEW!	70 - 71	297
0664 / 0665 / 0671	LUV WOOD BIG	72 - 75	312
0646	MILANO NEW!	58 - 59	296
0628	MOON NEW!	64 - 65	303
0629 / 0662 / 0663	MOON BIG	66 - 69	310
0650	MOULE	98 - 99	308
0105	NEST	238 - 239	337
0373	NICK	266 - 267	339
0657	NOBB	106 - 109	310
0254 / 0255	NOMA	182 - 183	345
0507	OBLONG	212 - 213	330
0601	OH! wood	140 - 141	317
0601	OH! zamak	142 - 143	318
0648	OMEGA	96 - 97	307
0372	ONA	180 - 181	343
0392	ORION	280	349
0553	OTO	176 - 177	322
0444	PEAK	252 - 253	342
0516	PENDANT	218 - 219	333
0390	PETRA	279	349
0674	PIECE NEW!	56 - 57	298
0597	PLIÉ	124 - 125	315
0636	POINT	80 - 83	305
0638	PRISM	90 - 91	306
0604	PRISMA	150 - 151	318
0487	PURA	118 - 119	314
0616	QUART	154 - 155	319
0608	QUART MINI	152 - 153	319
0511	RAIL	204 - 205	329
0091	RASO	291	352
0405	RAVIOLO	276 - 277	348
0226	REDO	274 - 275	348
0528	RILLE	116 - 117	313
0621	RILLE MINI	114 - 115	313
0552	RIM	174 - 175	322
0645	RISS	102 - 103	309
0655	RISS BIG	104 - 105	309
0241	ROMA	208 - 209	330
0499	ROUND	200 - 201	327
0195	SENSE	246 - 247	338
0301	SENSE MINI	244 - 245	338
0666	SIX NEW!	60 - 61	296
0380	STEEP	262	346
0073	TAP	242 - 243	338
0056	U	206 - 207	329
0602	VALLEY	144 - 147	318
0375	VANN	78 - 79	342
0434	VECTOR	258 - 259	345
0119	WAVE	236 - 237	336
0518	WAY	202 - 203	328
0600	WING	126 - 129	315

**Knobs &
handles**

**2025
collection**

viefe.com

Viefe®

**Knobs &
handles**

**2025
collection**

viefe.com

**info@viefe.com
T +34 938584029**

**C/ Dels Traginers 2
Sant Pere de Torelló
08572 Barcelona
Spain**

Viefe®

